

2026 MULE PRO-FXT 1000 LE Ranch Edition

PARTS DIAGRAM

Ignition Switch

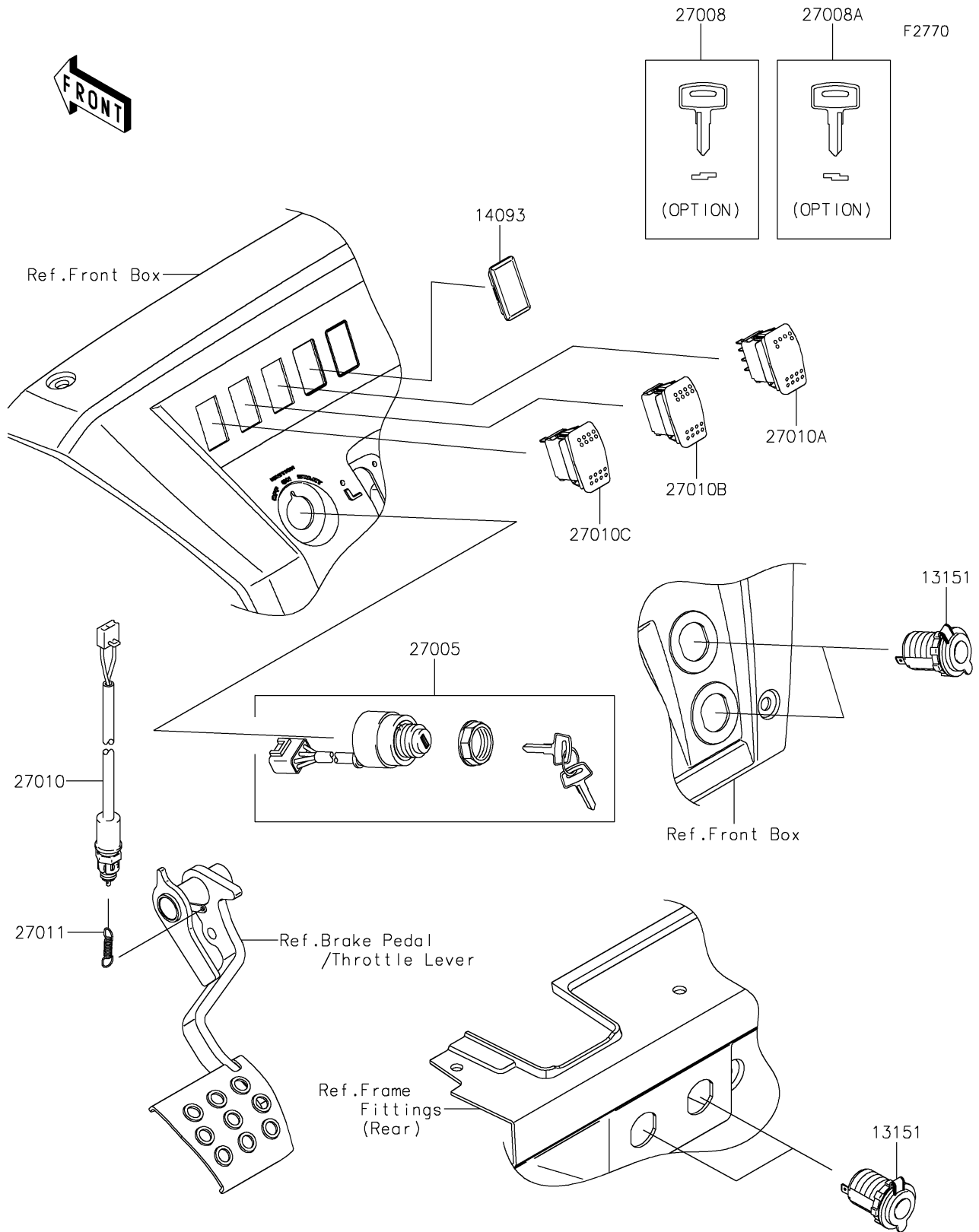

2026 MULE PRO-FXT 1000 LE Ranch Edition

PARTS LIST

Ignition Switch

ITEM NAME	PART NUMBER	QUANTITY
SWITCH-COMP,OUTLET,12V (Ref # 13151)	13151-0556	4
COVER,SWITCH (Ref # 14093)	14093-1202	1
SWITCH-ASSY-IGNITION (Ref # 27005)	27005-0643	1
KEY-LOCK,BLANK (Ref # 27008)	27008-1153	1
KEY-LOCK,BLANK (Ref # 27008A)	27008-1157	1
SWITCH,BRAKE (Ref # 27010)	27010-0724	1
SWITCH,HEAD LAMP (Ref # 27010A)	27010-0750	1
SWITCH,2WD/4WD (Ref # 27010B)	27010-0751	1
SWITCH,DIFF LOCK (Ref # 27010C)	27010-0810	1
SPRING,BRAKE LAMP SWITCH (Ref # 27011)	27011-006	1