

2026 MULE PRO-FXT 1000 LE Ranch Edition

PARTS DIAGRAM

Meter(s)

F2530

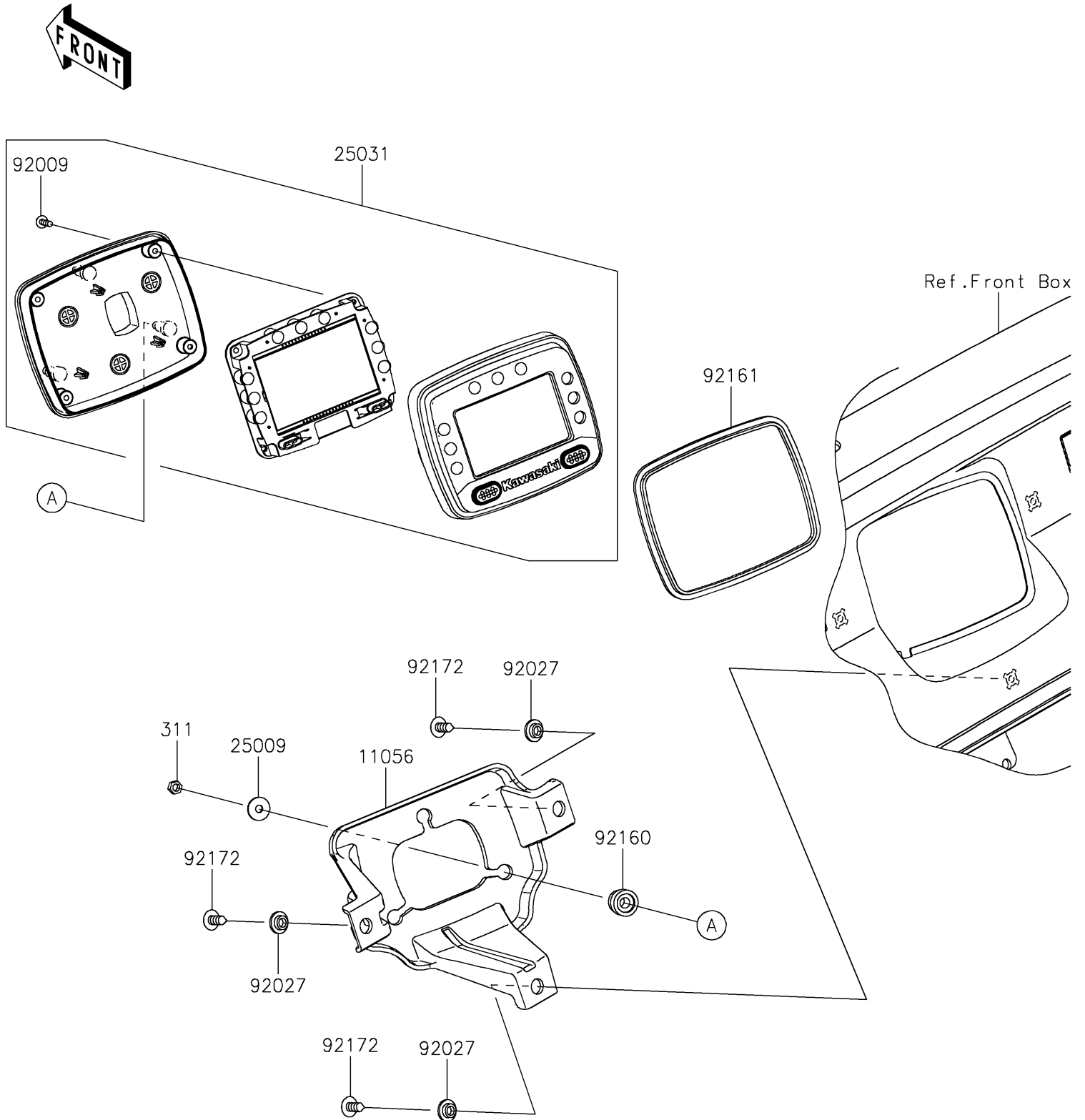

2026 MULE PRO-FXT 1000 LE Ranch Edition



PARTS LIST

Meter(s)

ITEM NAME	PART NUMBER	QUANTITY
-----------	-------------	----------
