

2026 MULE PRO-FXT 1000 LE Ranch Edition

PARTS DIAGRAM Front Hubs/Brakes

F2230

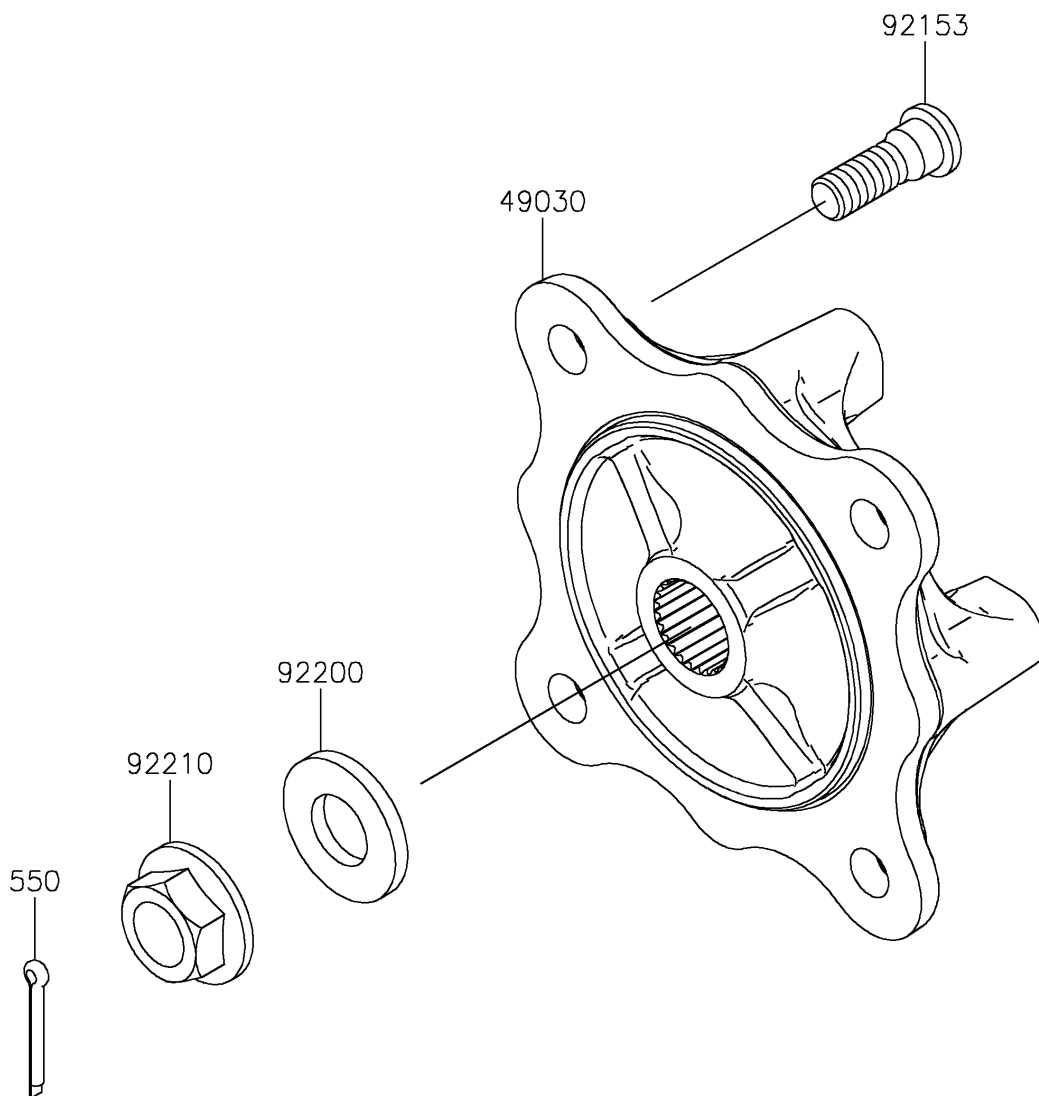

2026 MULE PRO-FXT 1000 LE Ranch Edition



PARTS LIST Front Hubs/Brakes

ITEM NAME	PART NUMBER	QUANTITY
-----------	-------------	----------
