

2025 MULE PRO-FXT 1000 LE Ranch Edition

PARTS DIAGRAM

Drive Shaft-Rear

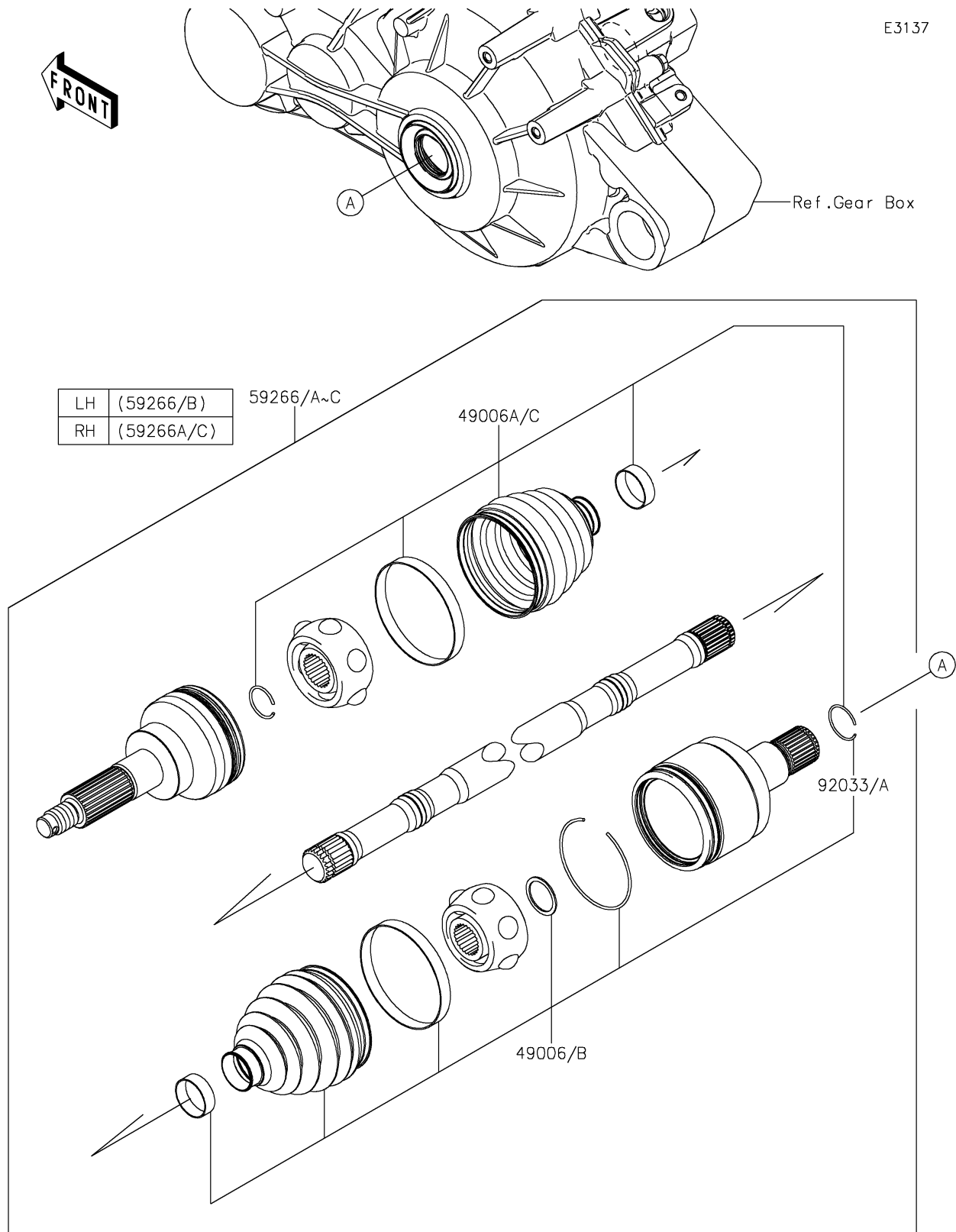

2025 MULE PRO-FXT 1000 LE Ranch Edition



PARTS LIST

Drive Shaft-Rear

ITEM NAME	PART NUMBER	QUANTITY
BOOT,INSIDE (Ref # 49006)	49006-0585	2
BOOT,OUTSIDE (Ref # 49006A)	49006-0586	2
JOINT-BALL,RR,LH (Ref # 59266)	59266-0049	1
JOINT-BALL,RR,RH (Ref # 59266A)	59266-0050	1
RING-SNAP (Ref # 92033)	92033-0838	2