

# 2026 MULE PRO-FXT™ 1000 LE RANCH EDITION

## PARTS DIAGRAM

### Oil Pan

E1434

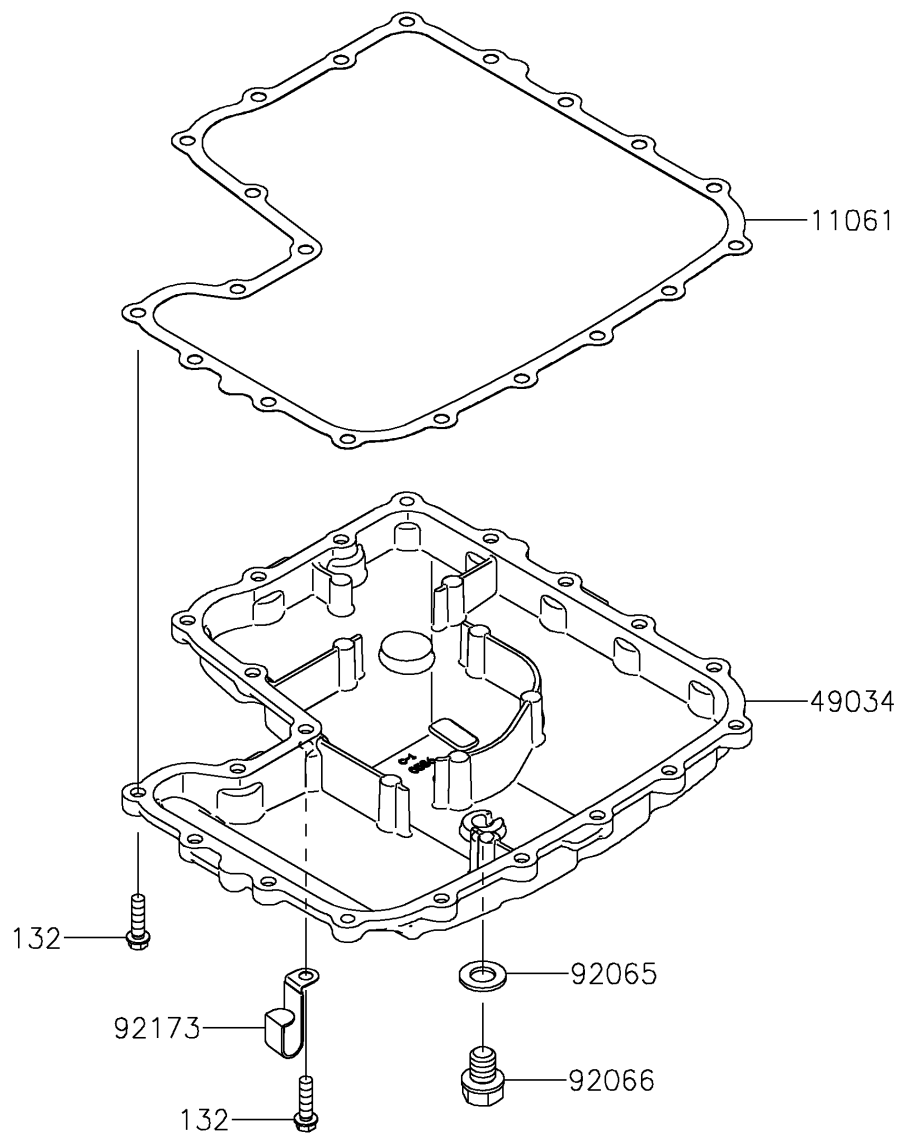

# 2026 MULE PRO-FXT™ 1000 LE RANCH EDITION



## PARTS LIST

### Oil Pan

ITEM NAME	PART NUMBER	QUANTITY
GASKET,OIL PAN (Ref # 11061)	11061-1306	1
PAN-OIL (Ref # 49034)	49034-0586	1
GASKET,12X22X2 (Ref # 92065)	92065-097	1
PLUG,OIL DRAIN,12X15 (Ref # 92066)	92066-1174	1
CLAMP (Ref # 92173)	92173-2336	1
BOLT-FLANGED-SMALL,6X22 (Ref # 132)	132BB0622	20