

2026 MULE PRO-FXT 1000 LE Ranch Edition

PARTS DIAGRAM

Driven Converter/Drive Belt

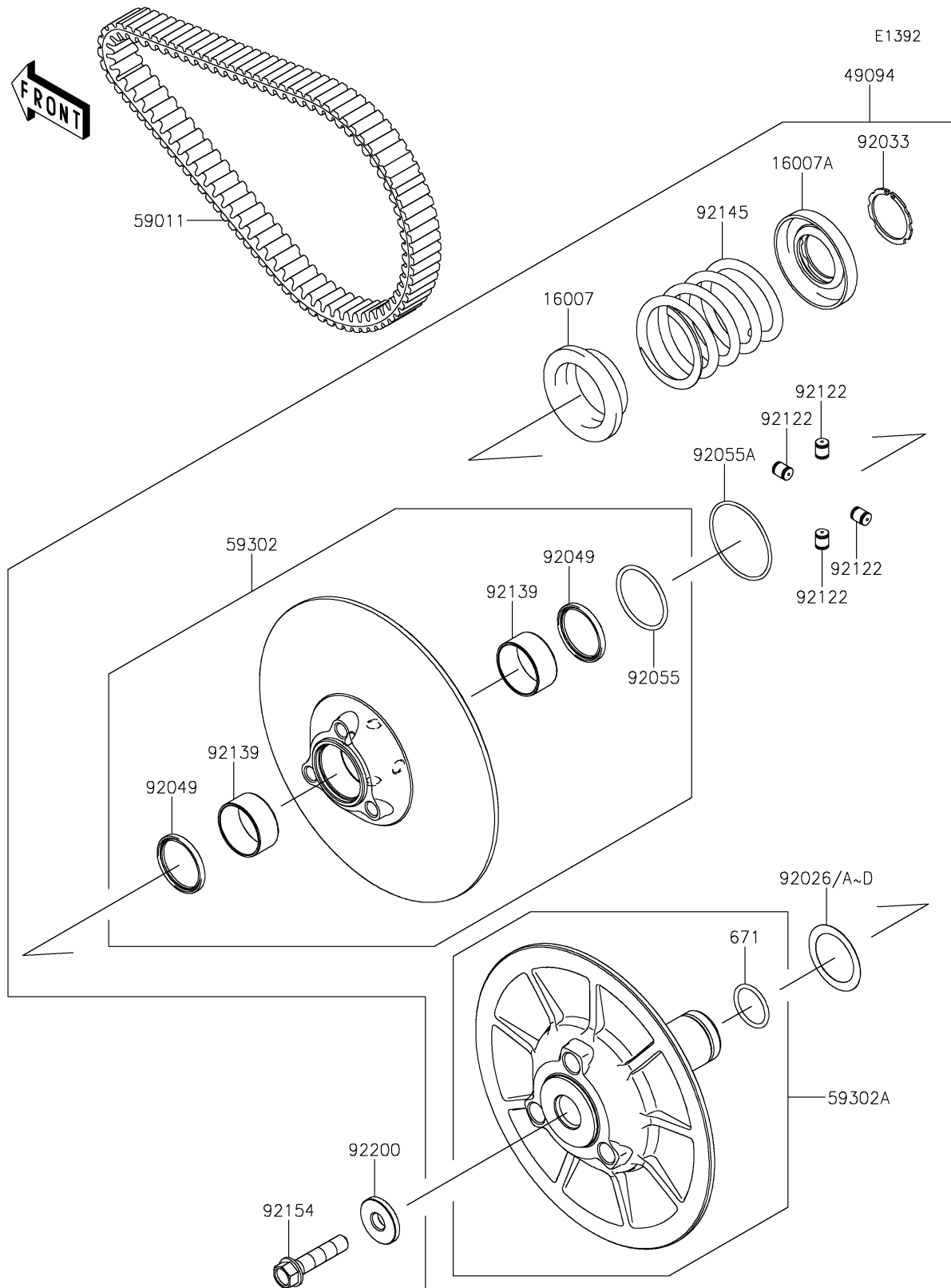

2026 MULE PRO-FXT 1000 LE Ranch Edition



PARTS LIST

Driven Converter/Drive Belt

ITEM NAME	PART NUMBER	QUANTITY
-----------	-------------	----------
