

2026 NINJA H2[®]R ABS

PARTS DIAGRAM

Decals

F2861

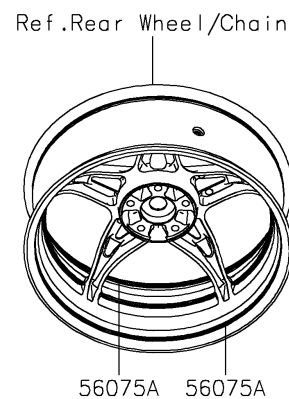
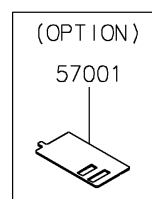
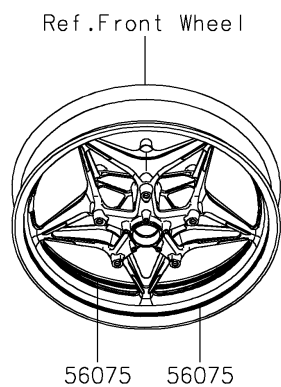
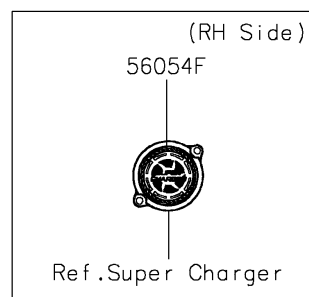
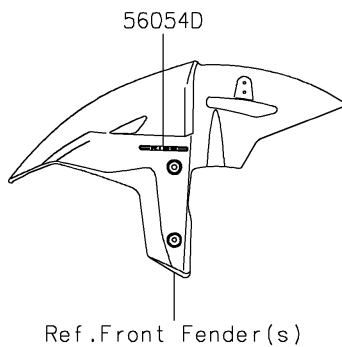
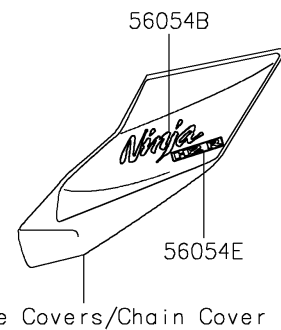
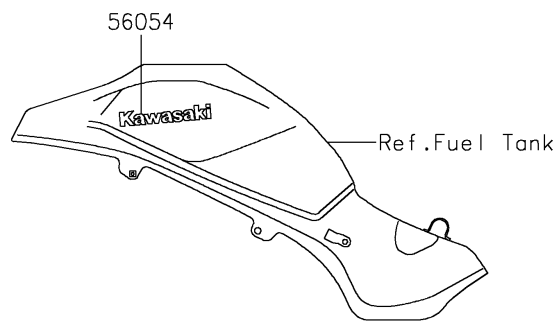
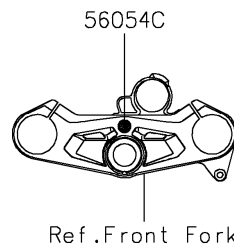
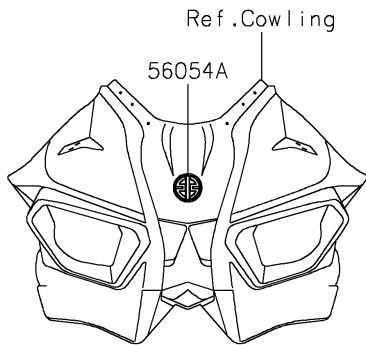

2026 NINJA H2[®]R ABS

PARTS LIST

Decals

| ITEM NAME | PART NUMBER | QUANTITY |
|---|-------------|----------|
| MARK,KAWASAKI (Ref # 56054) | 56054-1356 | 2 |
| MARK,UPP COWL.,RIVER (Ref # 56054A) | 56054-1557 | 1 |
| MARK,SIDE COVER,NINJA (Ref # 56054B) | 56054-1626 | 2 |
| MARK,UPP HOLDER,RIVER (Ref # 56054C) | 56054-1628 | 1 |
| MARK,FR FENDER,KIBS (Ref # 56054D) | 56054-2202 | 2 |
| MARK,SIDE COVER,H2R,3D (Ref # 56054E) | 56054-2203 | 2 |
| MARK,SUPERCHARGED (Ref # 56054F) | 56054-2533 | 1 |
| PATTERN,FR WHEEL,GREEN,10X1372 (Ref # 56075) | 56075-0433 | 2 |
| PATTERN,RR WHEEL,GREEN,12X1377 (Ref # 56075A) | 56075-0434 | 2 |
| RIM STRIPE APPLICATOR,10/12MM (Ref # 57001) | 57001-1836 | AR |