

2026 RIDGE® HVAC

PARTS DIAGRAM

Gear Change Drum/Shift Fork(s)

E1362

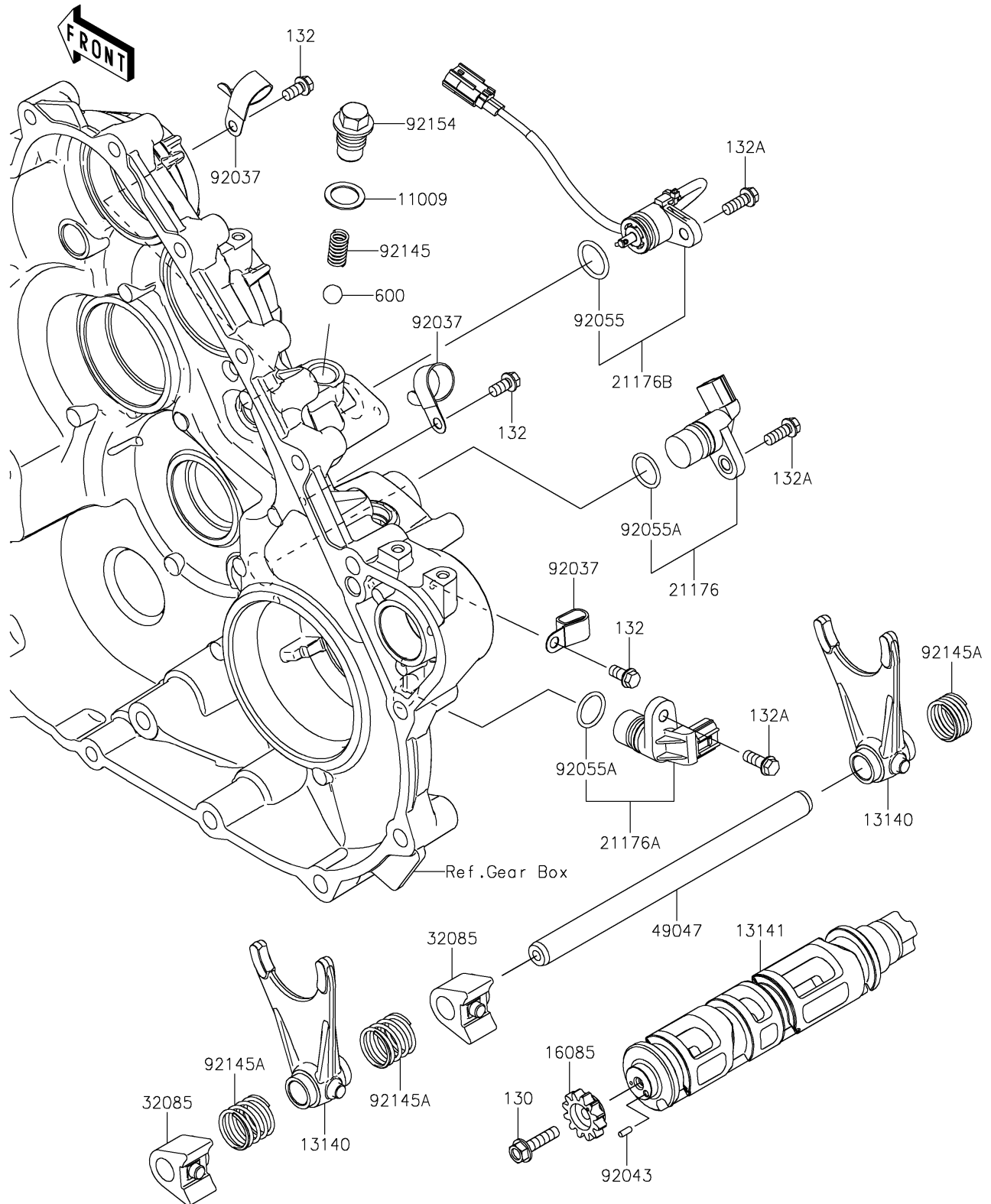

2026 RIDGE® HVAC

PARTS LIST

Gear Change Drum/Shift Fork(s)

ITEM NAME	PART NUMBER	QUANTITY
GASKET,15.5X22X1 (Ref # 11009)	11009-1008	1
FORK-SHIFT (Ref # 13140)	13140-0693	2
DRUM-CHANGE (Ref # 13141)	13141-0618	1
GEAR,12T (Ref # 16085)	16085-0738	1
SENSOR,SPEED (Ref # 21176)	21176-0767	1
SENSOR,DIFF LOCK (Ref # 21176A)	21176-0891	1
SENSOR,GEAR POSITION (Ref # 21176B)	21176-1183	1
STOPPER (Ref # 32085)	32085-0901	2
ROD-SHIFT (Ref # 49047)	49047-0641	1
CLAMP (Ref # 92037)	92037-1993	3
PIN,3X8 (Ref # 92043)	92043-1716	1
RING-O (Ref # 92055)	92055-0917	1
RING-O (Ref # 92055A)	92055-1639	2
SPRING (Ref # 92145)	92145-1590	1
SPRING (Ref # 92145A)	92145-2315	3
BOLT,CHANGE POSITION (Ref # 92154)	92154-1366	1
BOLT-FLANGED,6X25 (Ref # 130)	130CA0625	1
BOLT-FLANGED-SMALL,6X12 (Ref # 132)	132BA0612	3
BOLT-FLANGED-SMALL,6X16 (Ref # 132A)	132BA0616	3
BALL-STEEL,13/32 (Ref # 600)	600A1300	1