

# 2026 RIDGE® CREW HVAC

## PARTS DIAGRAM

### Front Hubs/Brakes

F2230

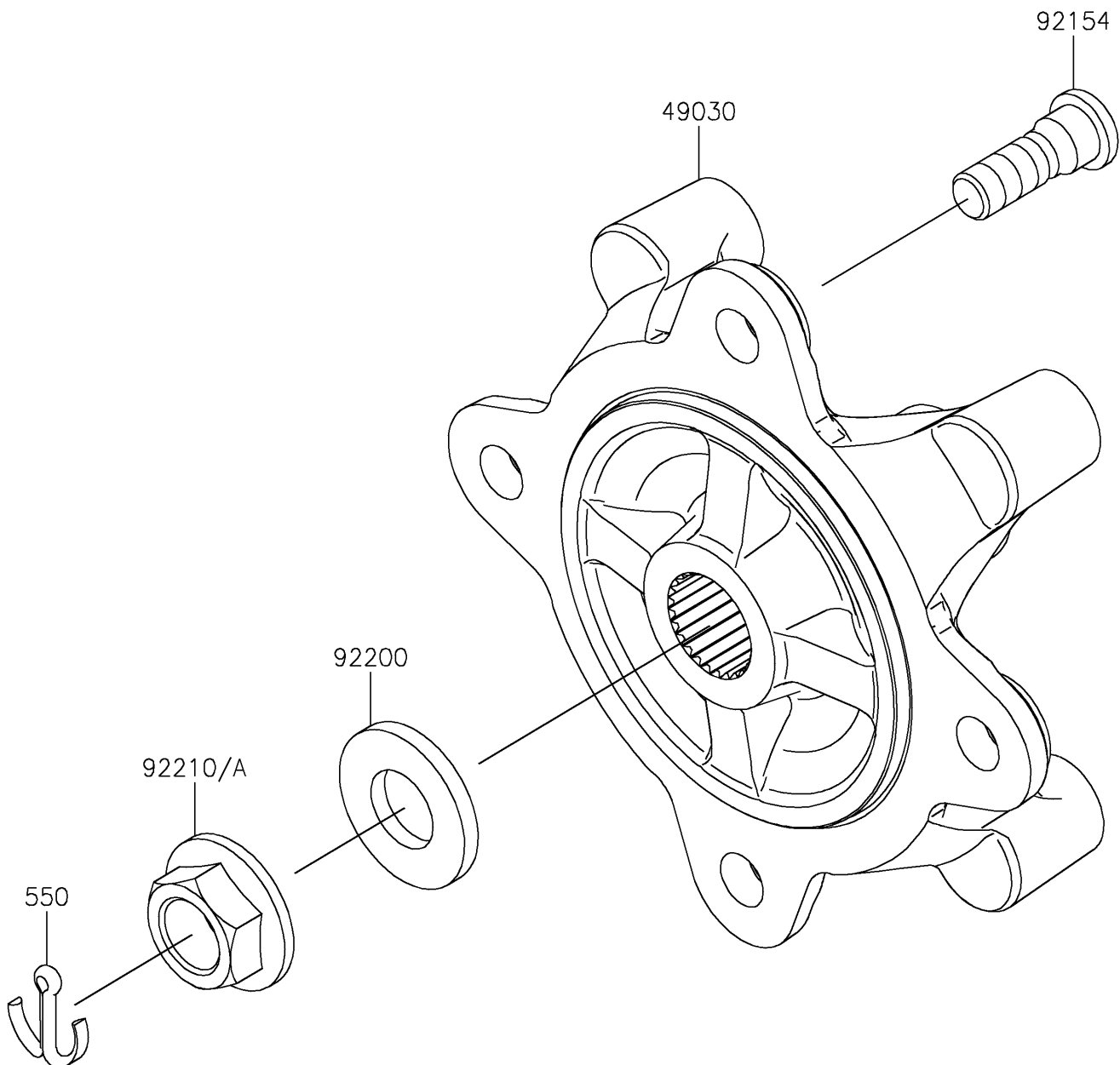

# 2026 RIDGE® CREW HVAC

## PARTS LIST

### Front Hubs/Brakes

ITEM NAME	PART NUMBER	QUANTITY
HUB,FR (Ref # 49030)	49030-0570	2
BOLT,12MM (Ref # 92154)	92154-7074	8
WASHER,20.3X41X4.5 (Ref # 92200)	92200-2609	2
NUT,FLANGED,20MM (Ref # 92210)	92210-1921	1
NUT,FLANGED,20MM (Ref # 92210A)	92210-2093	1
PIN-COTTER,4.0X30 (Ref # 550)	550AA4030	2