

# 2026 W230 ABS

## PARTS DIAGRAM

### Front Brake

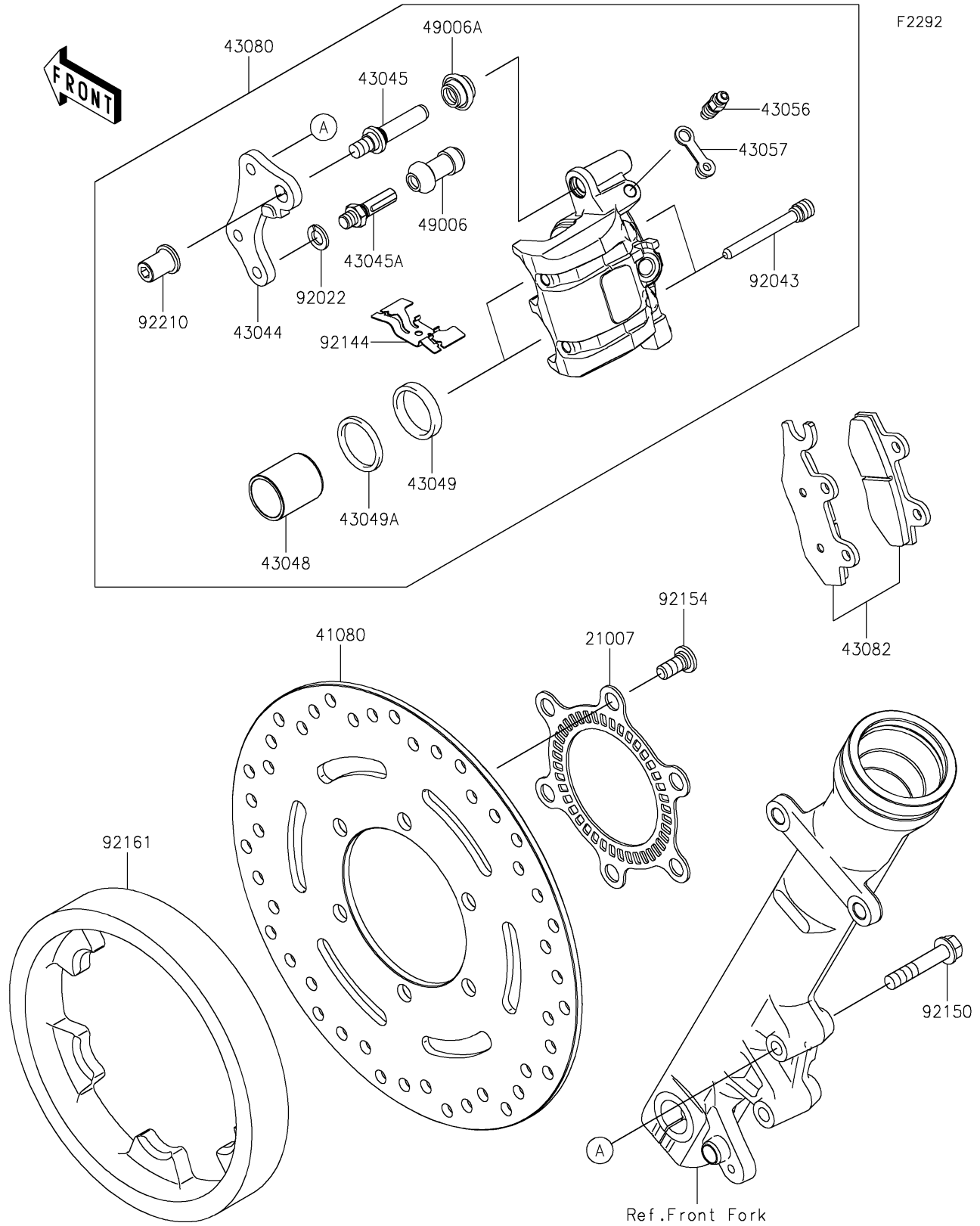

# 2026 W230 ABS

## PARTS LIST

### Front Brake

**ITEM NAME**

**PART NUMBER**

**QUANTITY**

---