

# 2025 W230

## PARTS DIAGRAM

### Crankcase

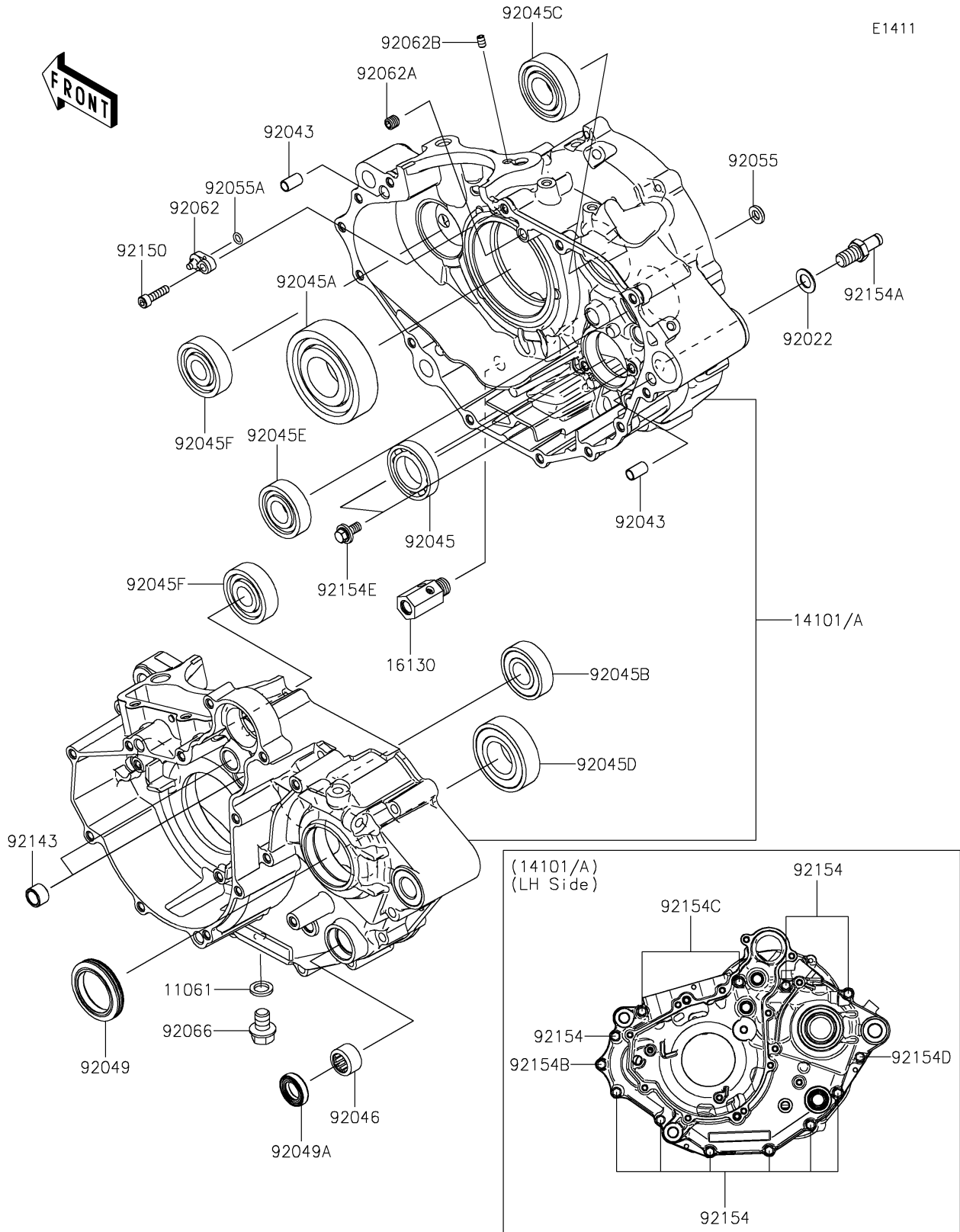

# 2025 W230

## PARTS LIST

### Crankcase

**ITEM NAME**

**PART NUMBER**

**QUANTITY**

---