

2026 NINJA H2® CARBON ABS

PARTS DIAGRAM

Taillight(s)

F2720

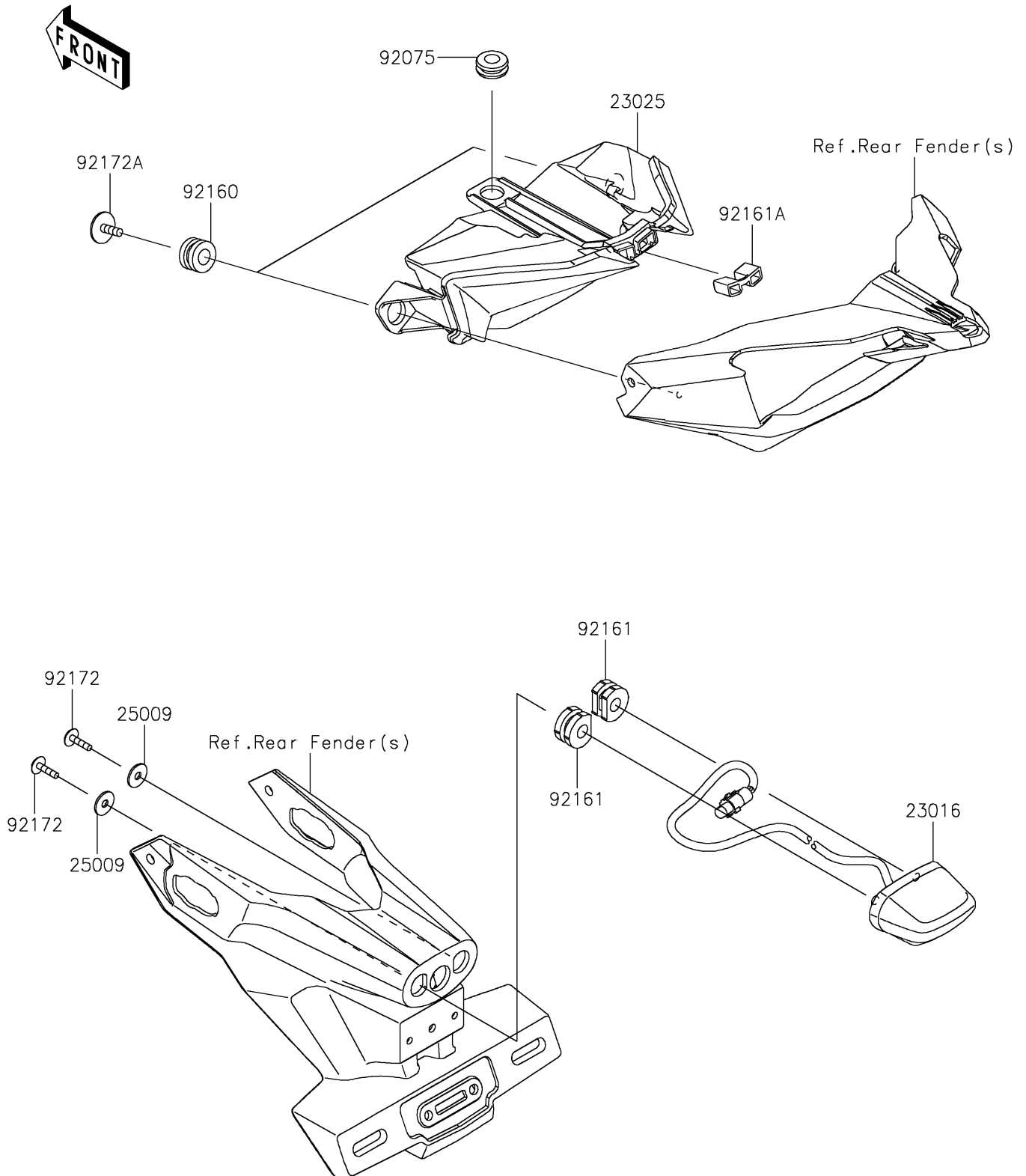

2026 NINJA H2[®] CARBON ABS

PARTS LIST

Taillight(s)

ITEM NAME	PART NUMBER	QUANTITY
LAMP-ASSY,LICENSE,LED (Ref # 23016)	23016-0639	1
LAMP-TAIL,LED (Ref # 23025)	23025-0346	1
WASHER,5.2X16X1.2 (Ref # 25009)	25009-004	2
DAMPER (Ref # 92075)	92075-1028	1
DAMPER,10X20X12 (Ref # 92160)	92160-1167	2
DAMPER (Ref # 92161)	92161-0776	2
DAMPER,RR FENDER (Ref # 92161A)	92161-1727	1
SCREW,TAPPING,5X16 (Ref # 92172)	92172-0238	2
SCREW,TAPTITE,5X16 (Ref # 92172A)	92172-0481	2