

2026 NINJA H2[®] CARBON ABS

PARTS DIAGRAM

Side Covers/Chain Cover

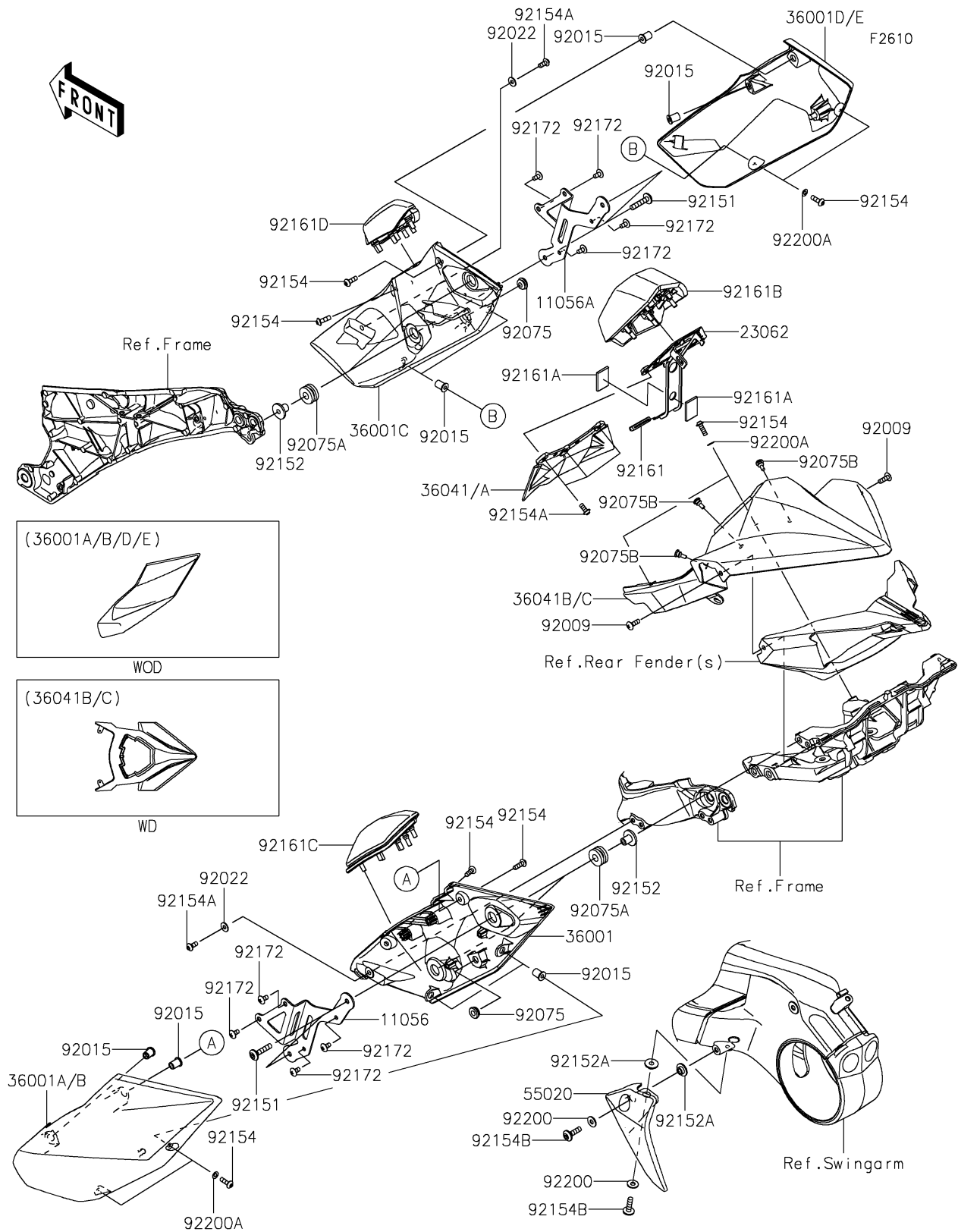

2026 NINJA H2[®] CARBON ABS

PARTS LIST

Side Covers/Chain Cover

ITEM NAME	PART NUMBER	QUANTITY
-----------	-------------	----------
