

2026 NINJA H2[®] CARBON ABS

PARTS DIAGRAM

Suspension/Shock Absorber

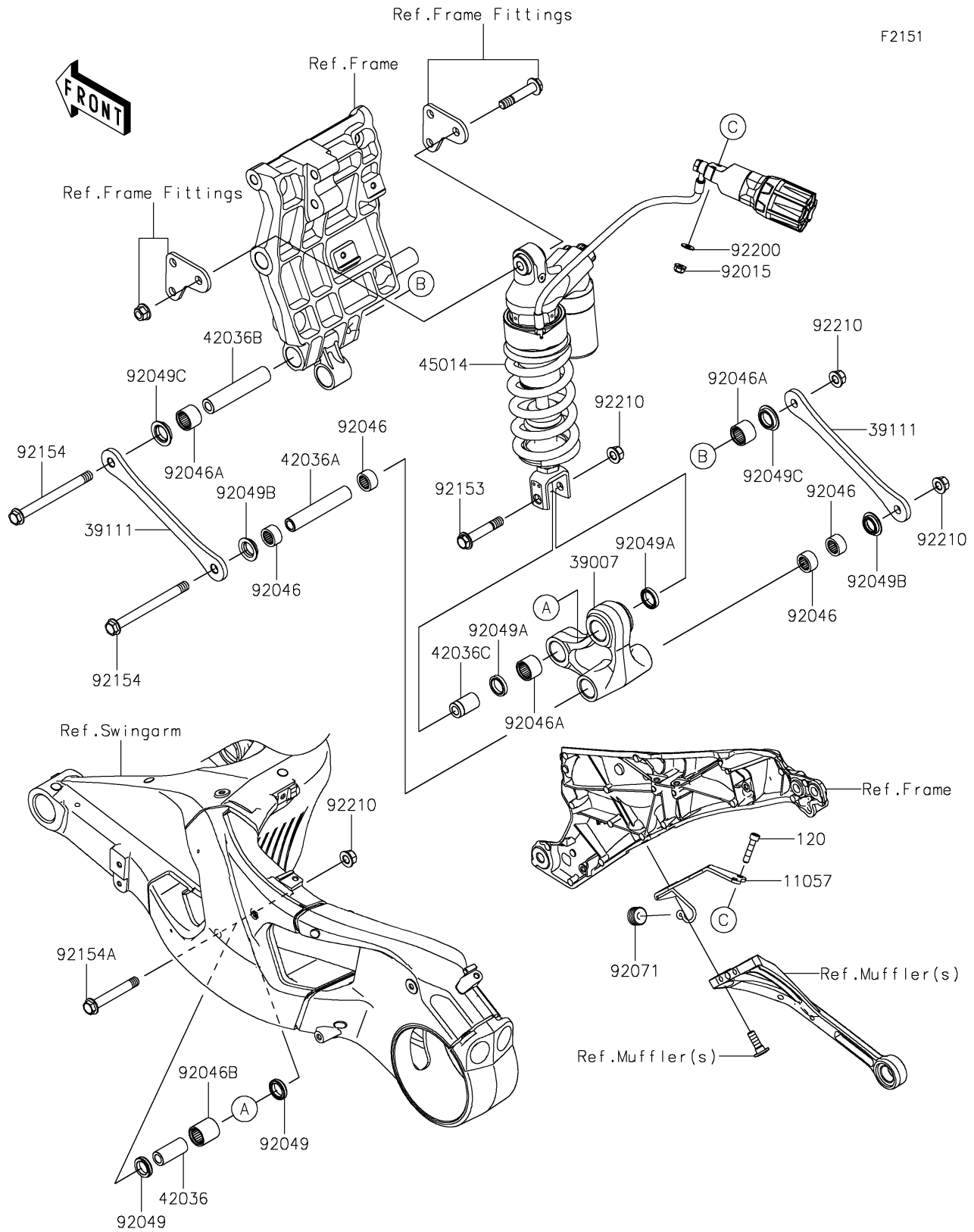

2026 NINJA H2[®] CARBON ABS

PARTS LIST

Suspension/Shock Absorber

ITEM NAME	PART NUMBER	QUANTITY
-----------	-------------	----------
