

2026 NINJA H2[®] CARBON ABS

PARTS DIAGRAM

Crankshaft/Piston(s)

E1320

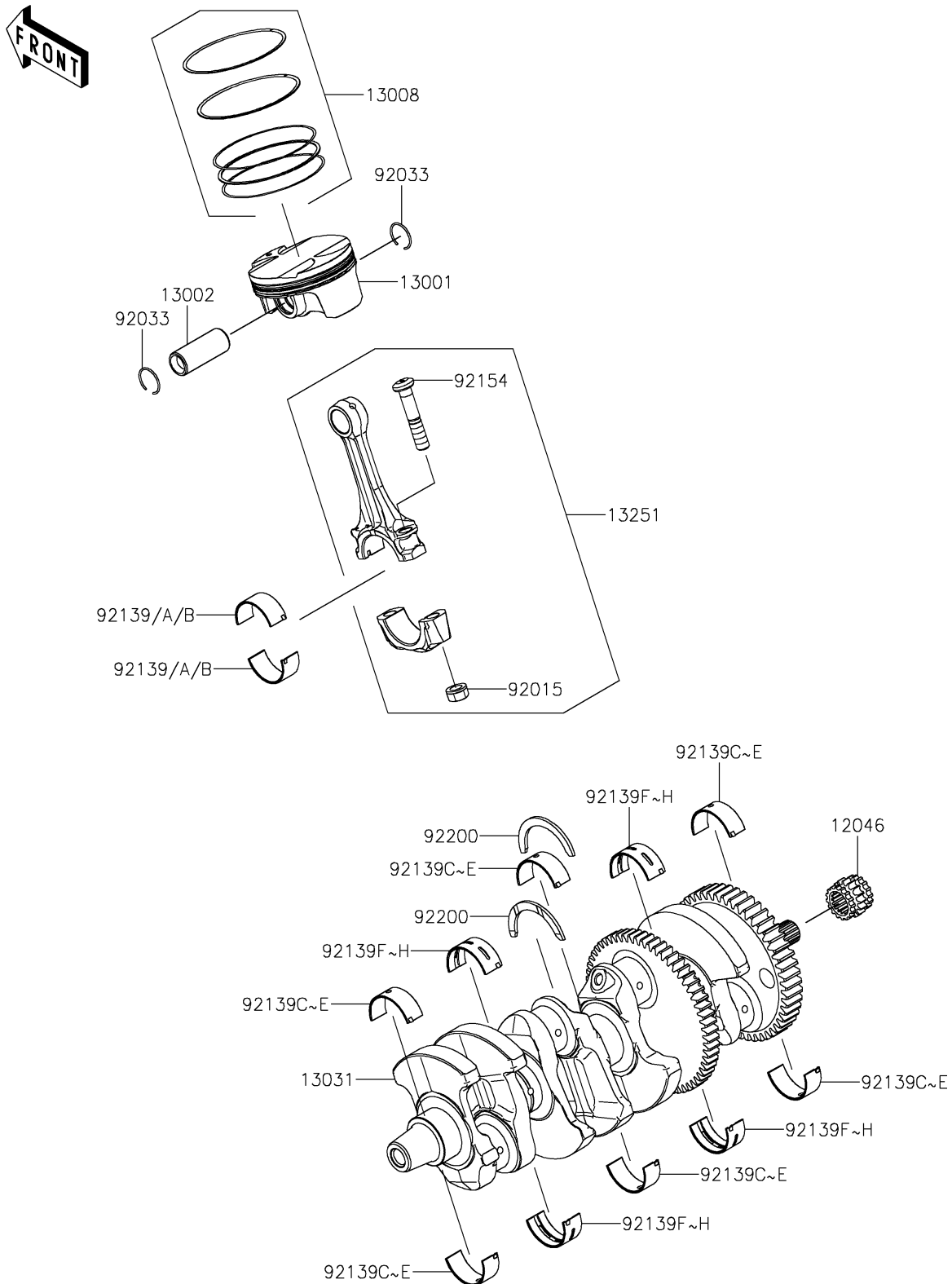

2026 NINJA H2[®] CARBON ABS

PARTS LIST

Crankshaft/Piston(s)

ITEM NAME	PART NUMBER	QUANTITY
-----------	-------------	----------
