

# 2026 Ultra 310LX

## PARTS DIAGRAM

### Muffler(s)

E1140

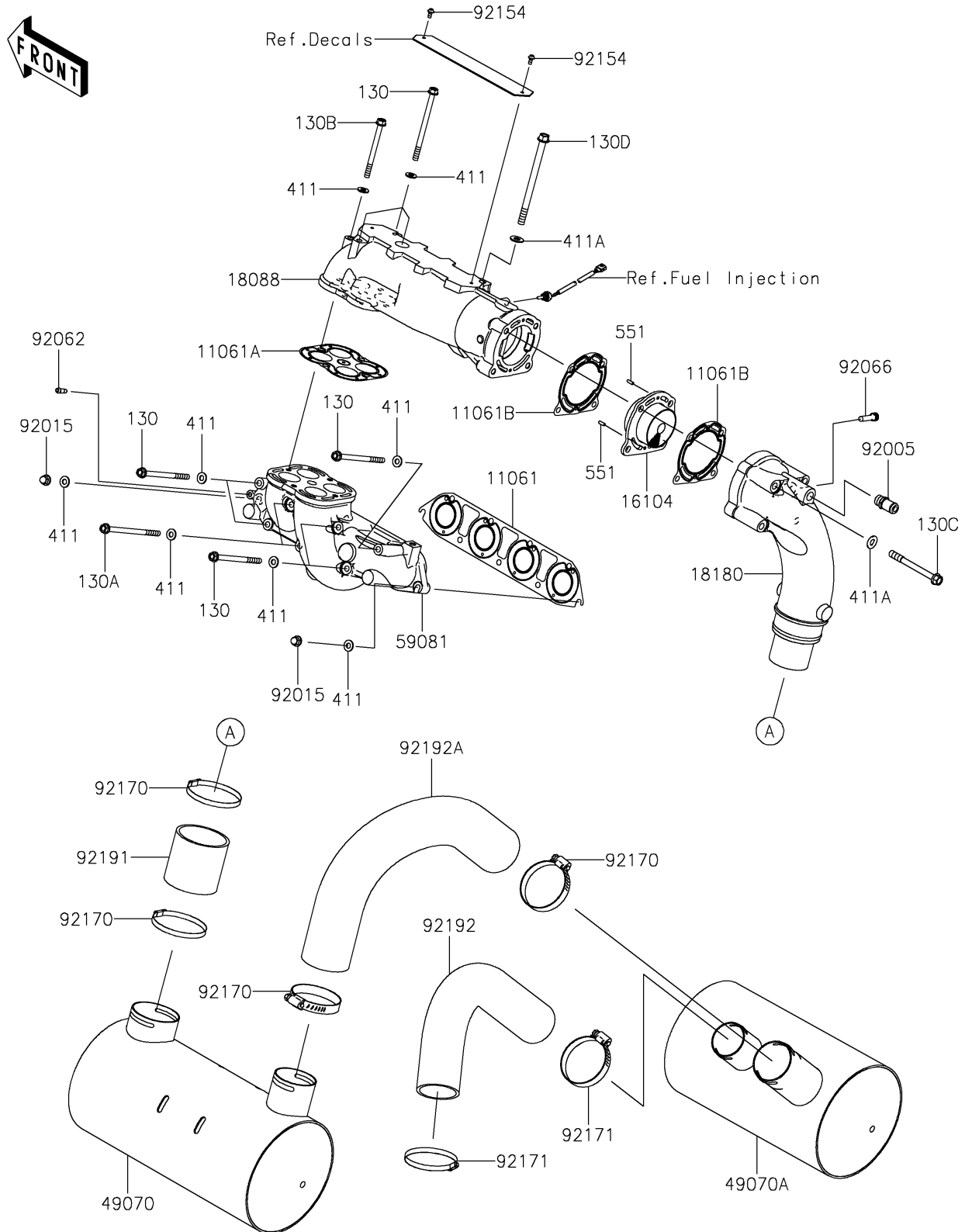

# 2026 Ultra 310LX

## PARTS LIST

Muffler(s)

**ITEM NAME**

**PART NUMBER**

**QUANTITY**

---