

2025 MULE SX™ 4x4 FE

PARTS DIAGRAM

Optional Parts

F2890



(Ref. Drive Converter)

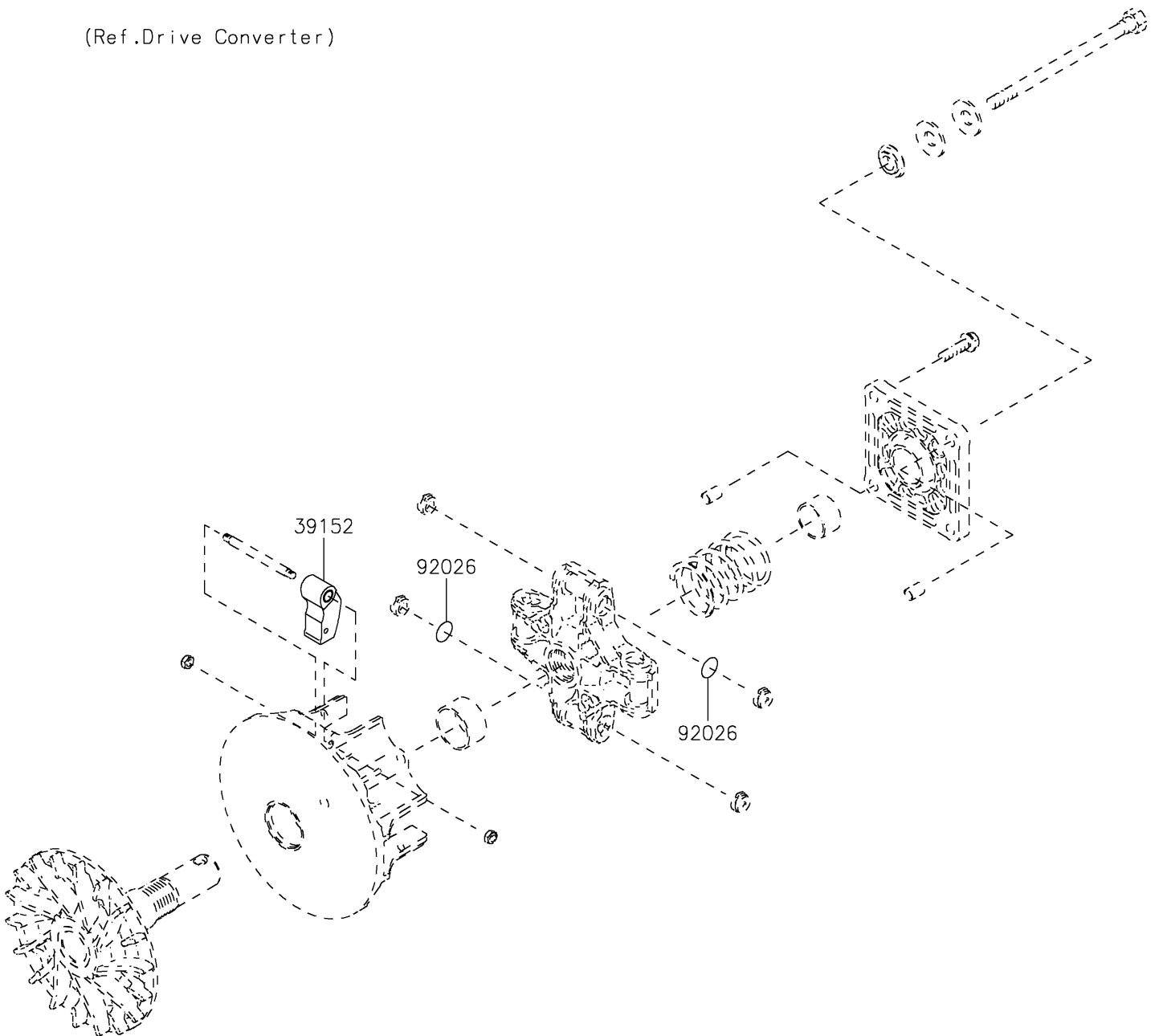

2025 MULE SX™ 4x4 FE

PARTS LIST

Optional Parts

ITEM NAME

PART NUMBER

QUANTITY
