

# 2024 MULE SX™ 4x4 FE

## PARTS DIAGRAM

### Labels

F2860

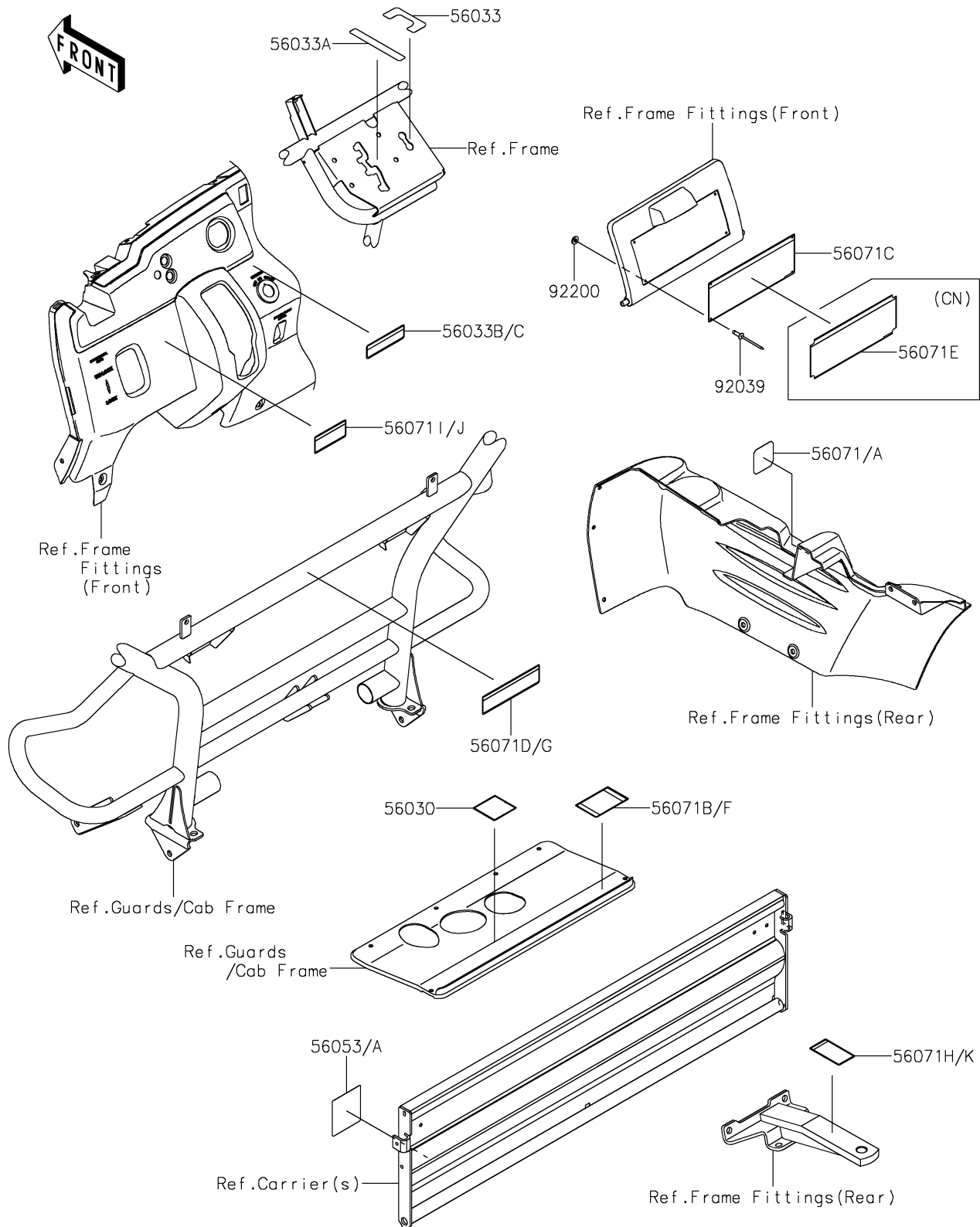

# 2024 MULE SX™ 4x4 FE

## PARTS LIST

### Labels

**ITEM NAME**

**PART NUMBER**

**QUANTITY**

---