

2025 MULE SX™ 4x4 FE

PARTS DIAGRAM

Taillight(s)

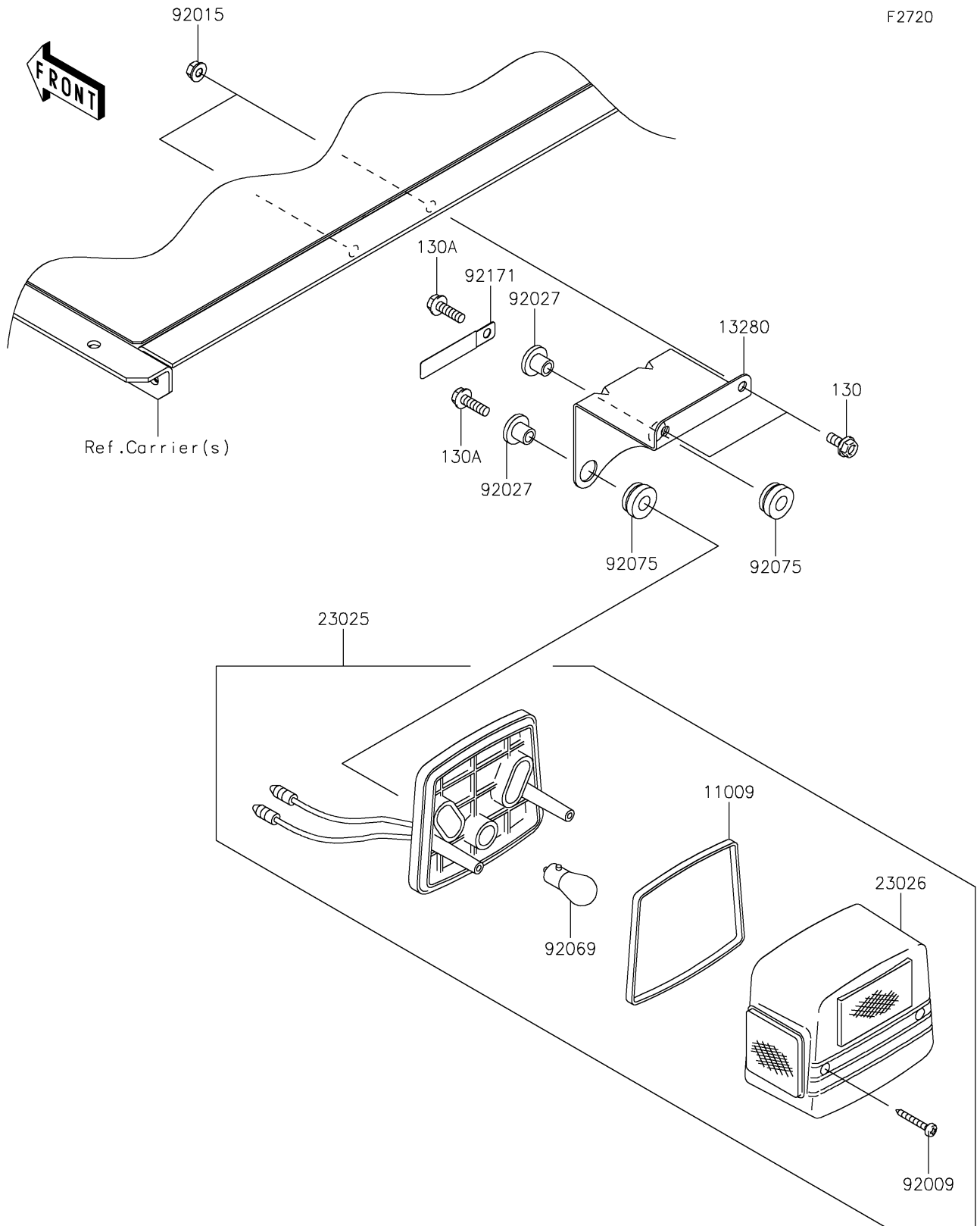

2025 MULE SX™ 4x4 FE

PARTS LIST

Taillight(s)

ITEM NAME	PART NUMBER	QUANTITY
-----------	-------------	----------
