

# 2025 MULE SX™ 4x4 FE

## PARTS DIAGRAM

### Shock Absorber(s)

F2280

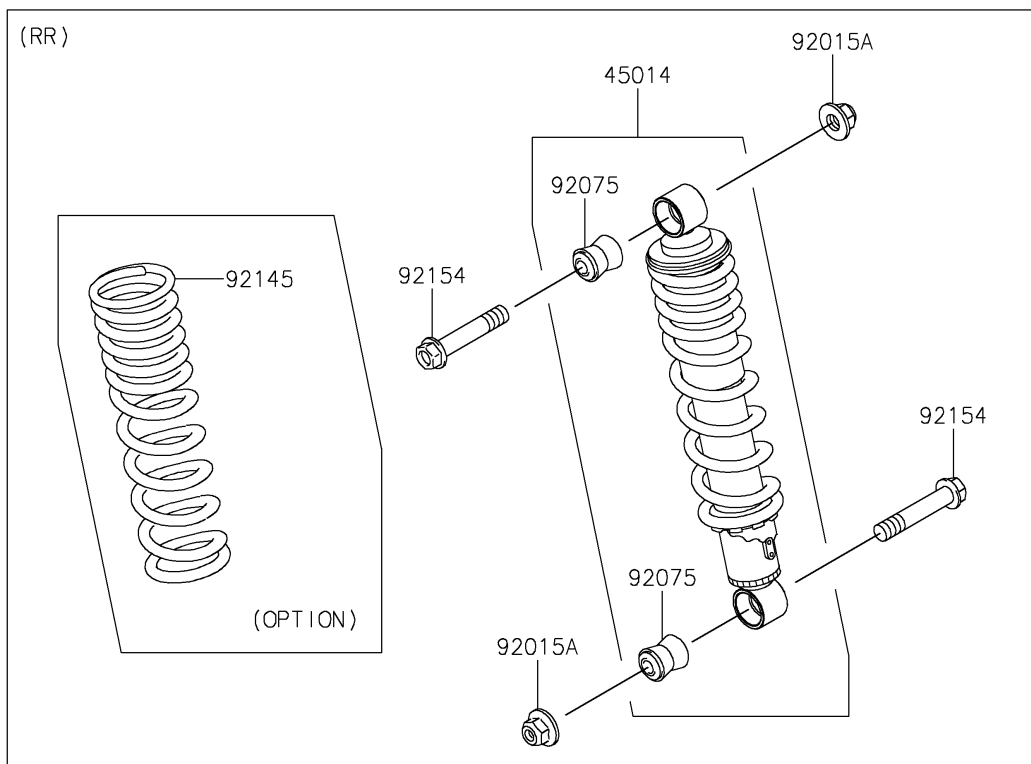
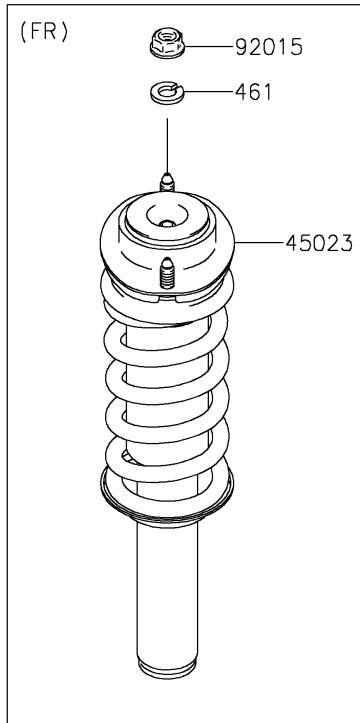

# 2025 MULE SX™ 4x4 FE

## PARTS LIST

### Shock Absorber(s)

ITEM NAME	PART NUMBER	QUANTITY
-----------	-------------	----------

---