

# 2025 MULE SX™ 4x4 FE

## PARTS DIAGRAM

### Differential

E1451

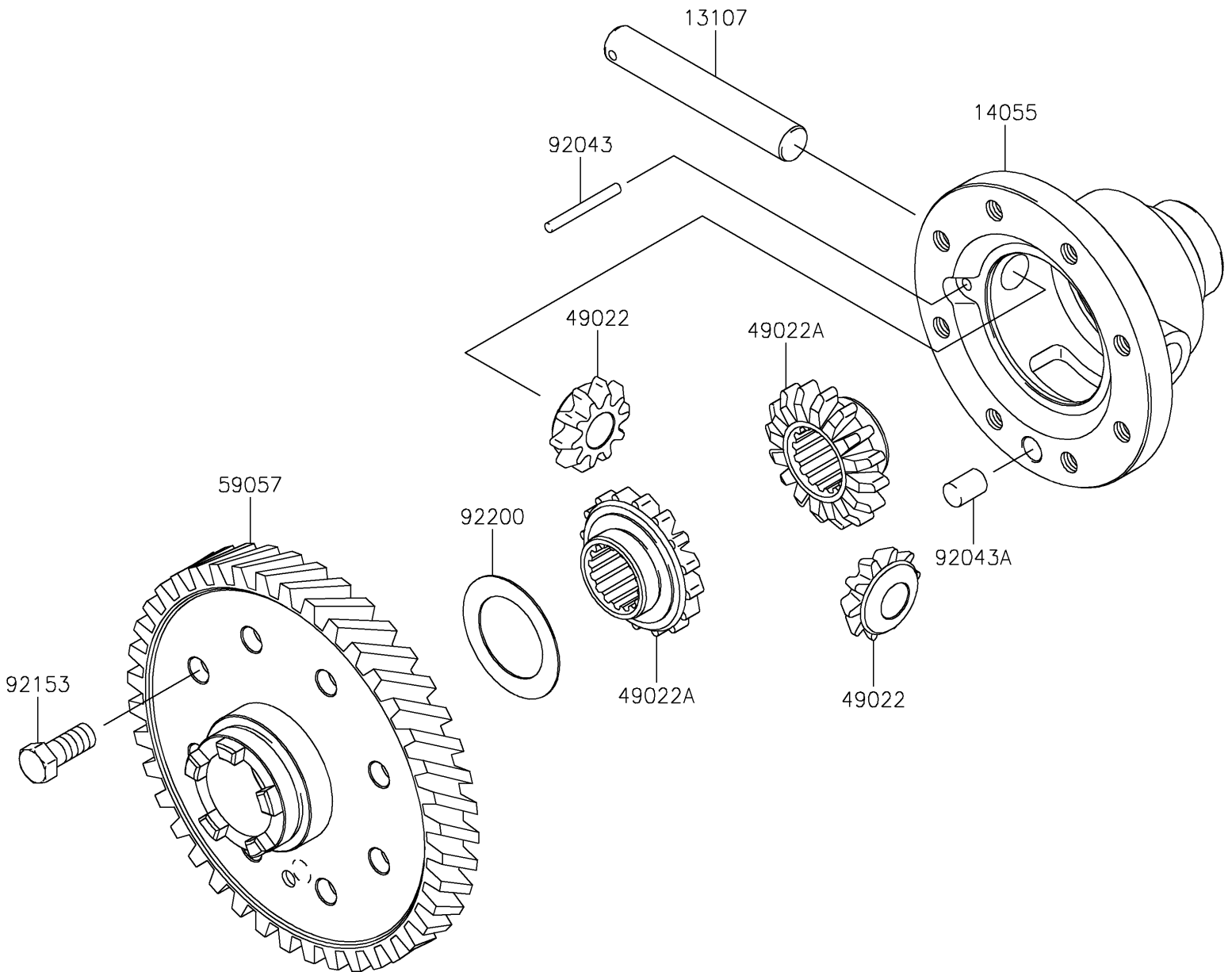

# 2025 MULE SX™ 4x4 FE

## PARTS LIST

### Differential

**ITEM NAME**

**PART NUMBER**

**QUANTITY**

---