

2026 VULCAN® S ABS

PARTS DIAGRAM

Cables

F2540

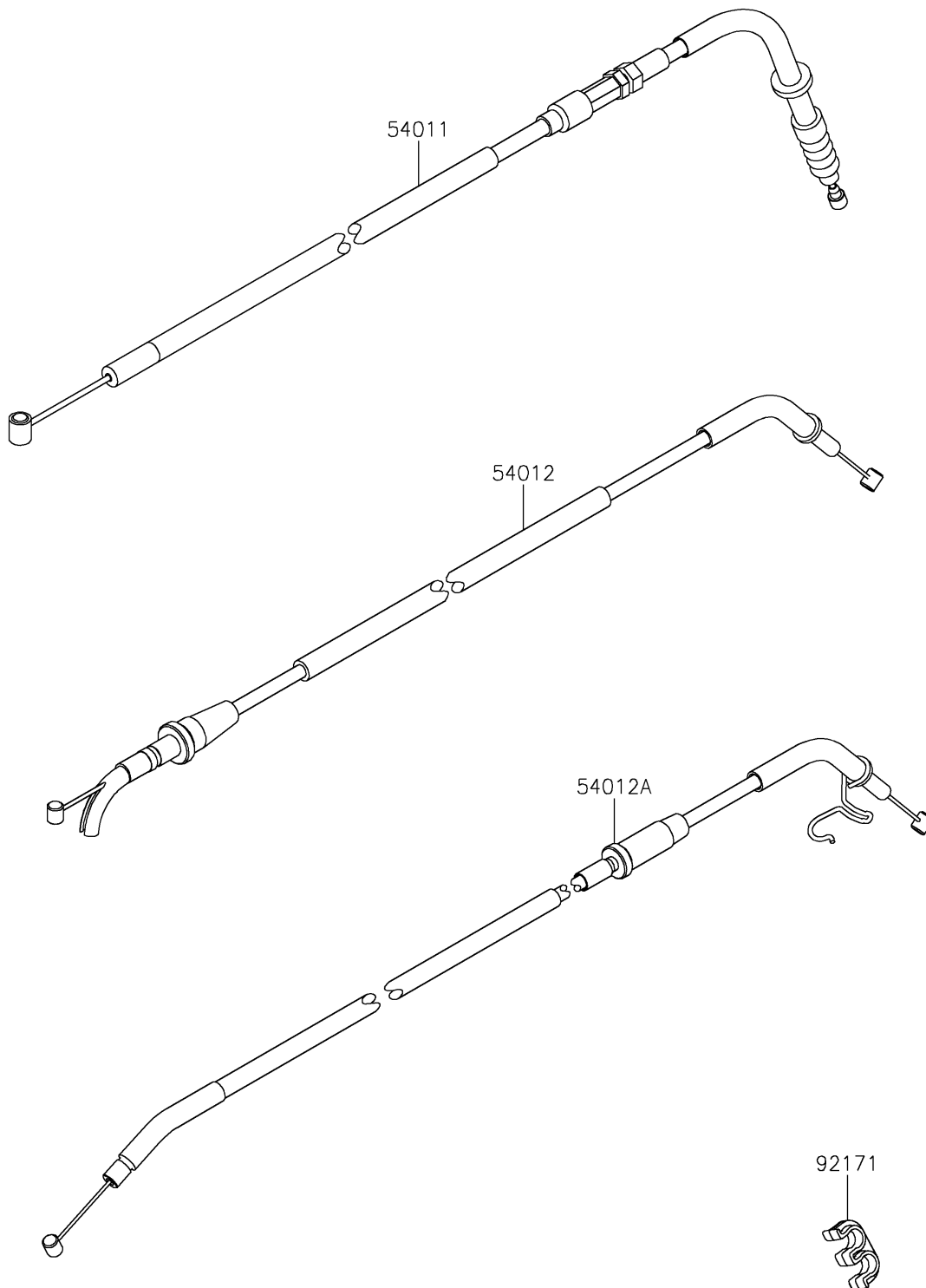

2026 VULCAN[®] S ABS

PARTS LIST

Cables

ITEM NAME

PART NUMBER

QUANTITY
