

# 2026 VULCAN® S ABS

## PARTS DIAGRAM

### Oil Pan

E1434

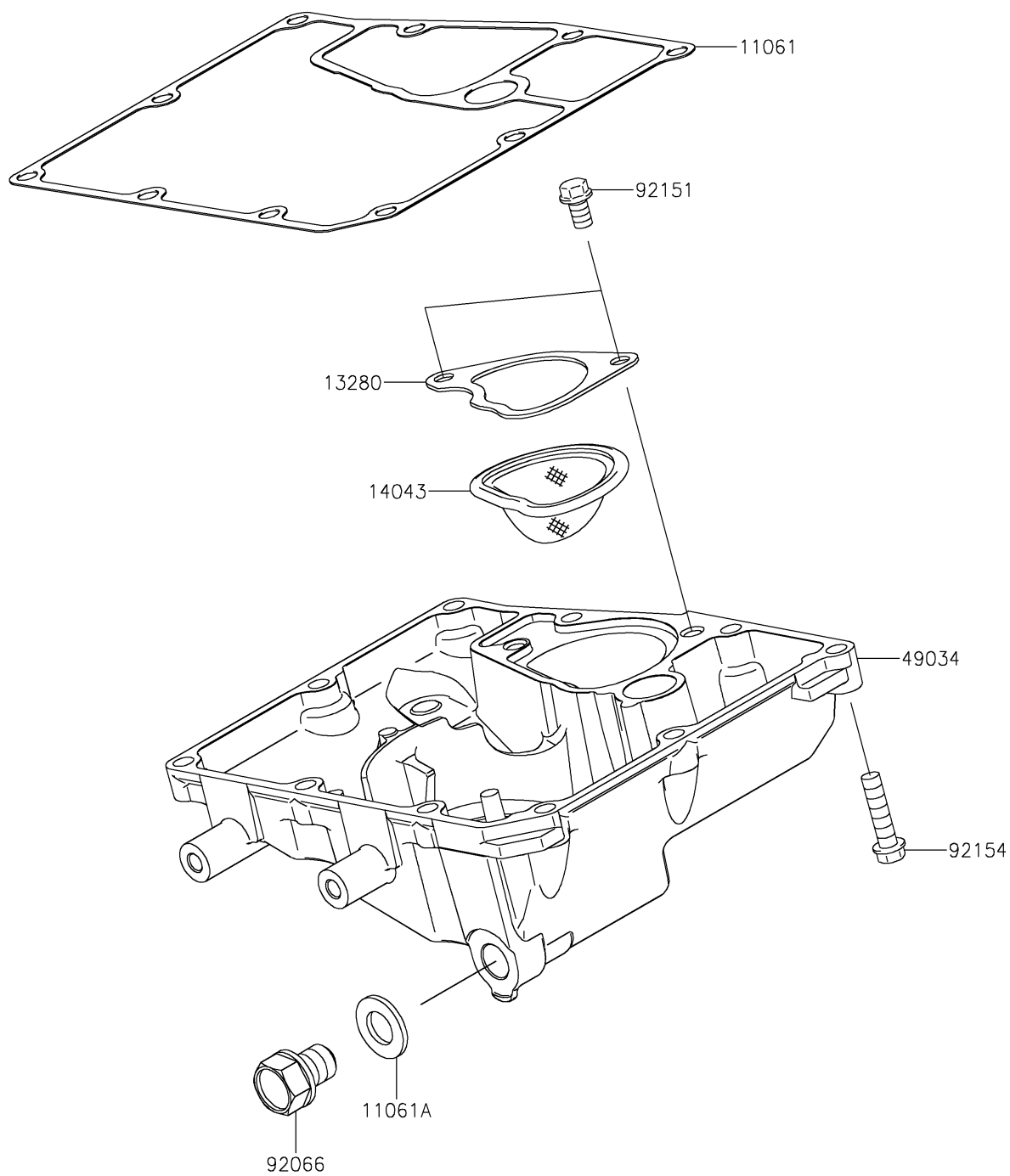

# 2026 VULCAN® S ABS

## PARTS LIST

Oil Pan

**ITEM NAME**

**PART NUMBER**

**QUANTITY**

---