

# 2025 JET SKI® ULTRA® 160LX-S

## PARTS DIAGRAM

### Throttle

E1510

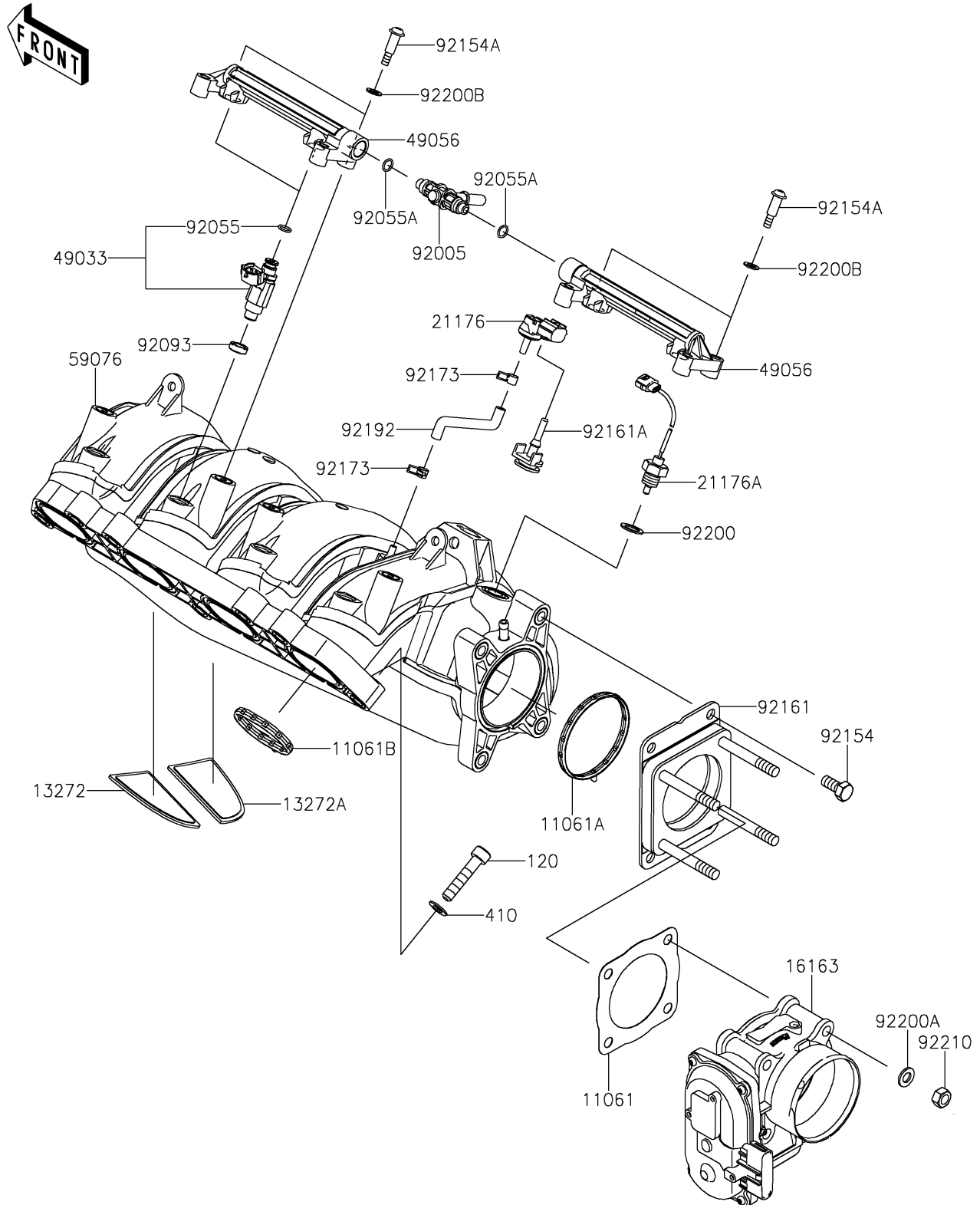

# 2025 JET SKI® ULTRA® 160LX-S

## PARTS LIST

### Throttle

ITEM NAME	PART NUMBER	QUANTITY
-----------	-------------	----------

---