

# 2026 MULE PRO-MX™ EPS CAMO

## PARTS DIAGRAM

### Crankcase

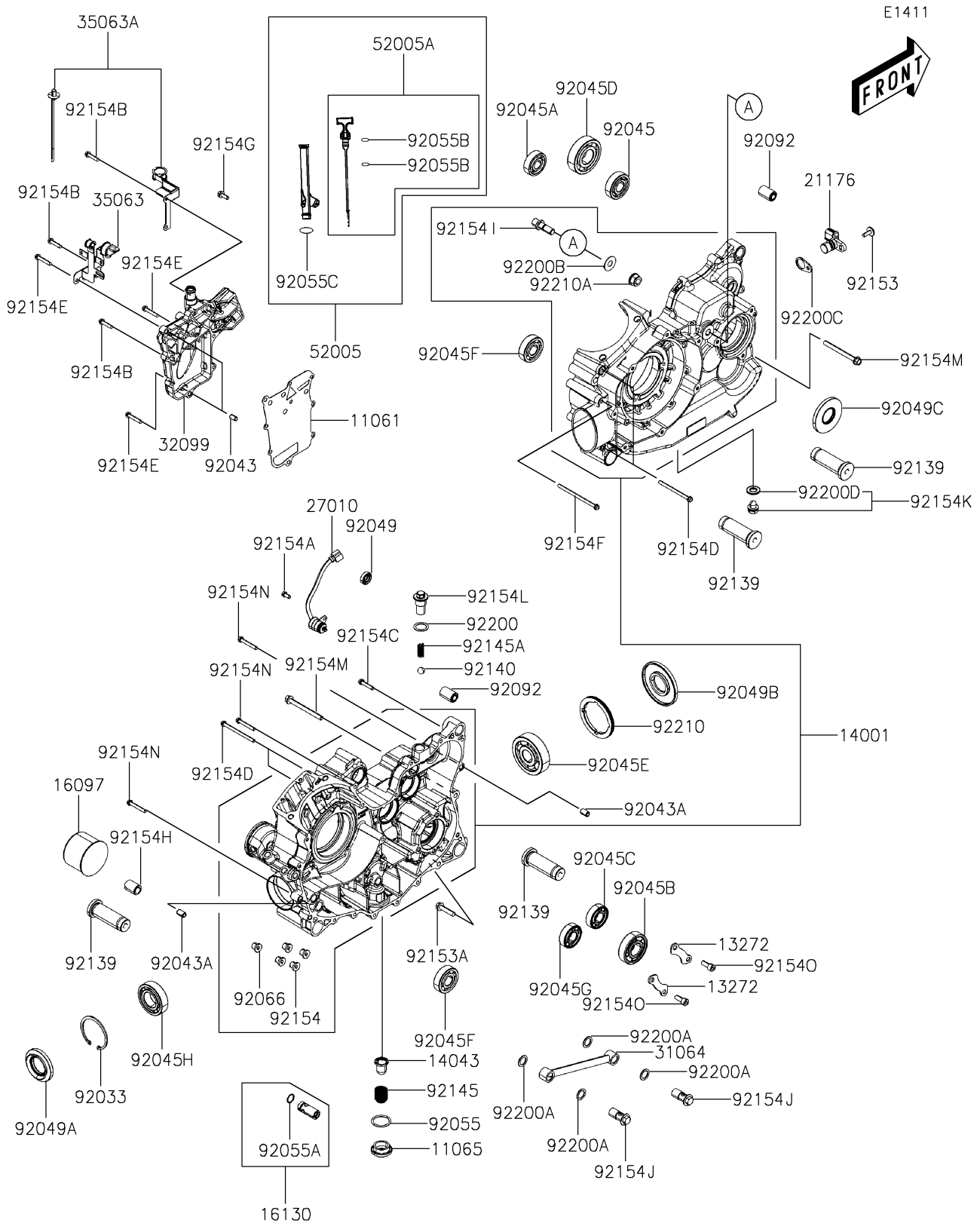

# 2026 MULE PRO-MX™ EPS CAMO

## PARTS LIST

### Crankcase

ITEM NAME	PART NUMBER	QUANTITY
-----------	-------------	----------

---