

2026 MULE PRO-MX™ EPS

PARTS DIAGRAM

Meter(s)

F2530

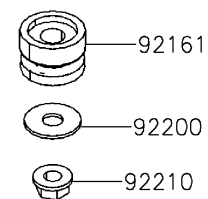
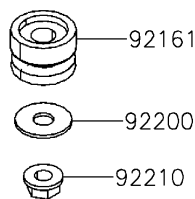
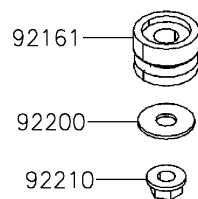
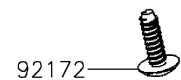
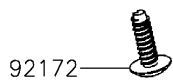
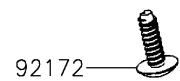
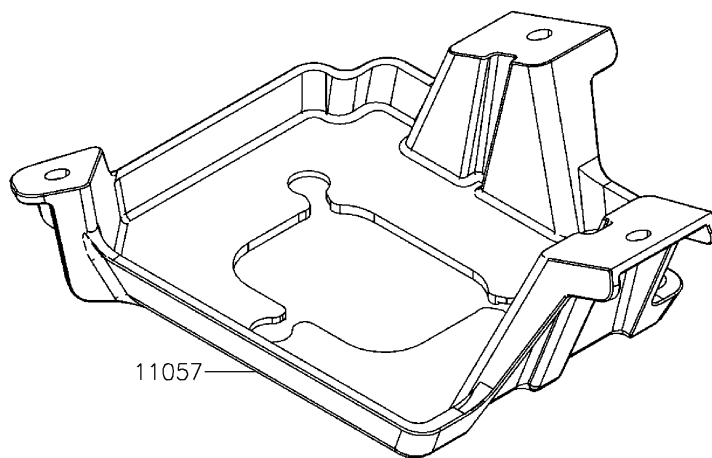
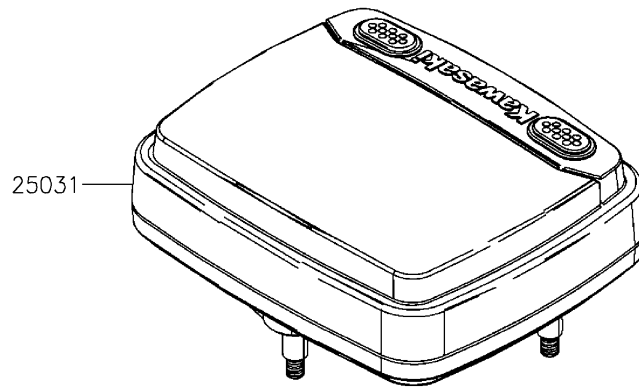

2026 MULE PRO-MX™ EPS

PARTS LIST

Meter(s)

ITEM NAME	PART NUMBER	QUANTITY
-----------	-------------	----------
