

2026 Mule PRO-MX EPS

PARTS DIAGRAM

Meter(s)

F2530

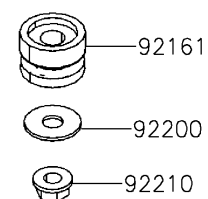
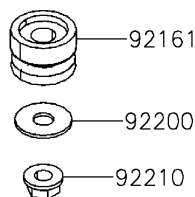
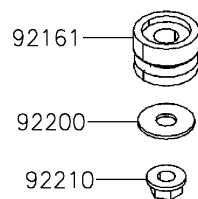
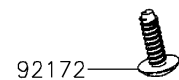
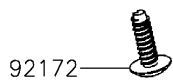
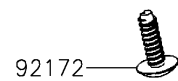
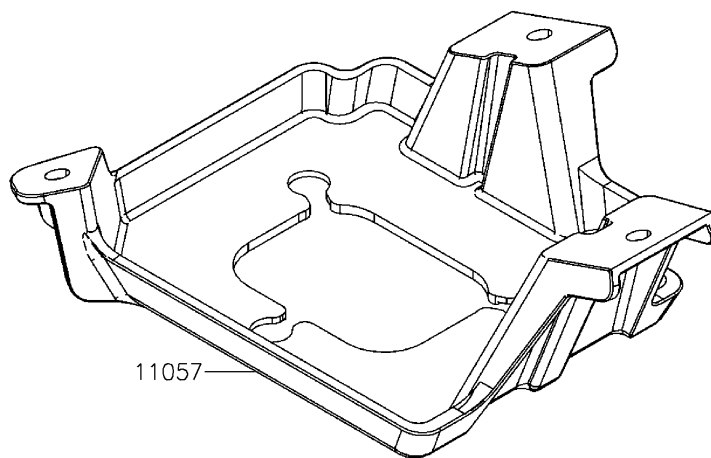
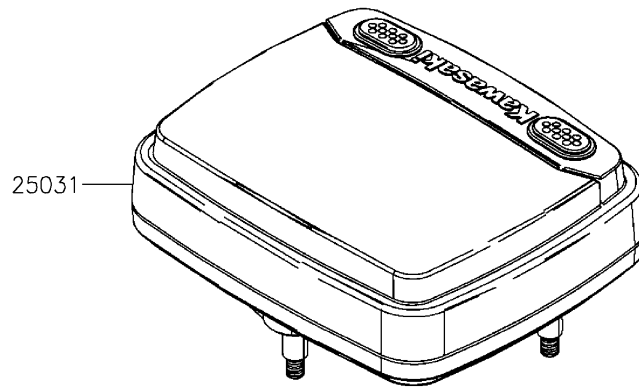

2026 Mule PRO-MX EPS

PARTS LIST

Meter(s)

ITEM NAME

PART NUMBER

QUANTITY
