

# 2026 MULE PRO-MX™ EPS

## PARTS DIAGRAM

### Cylinder/Piston(s)

E1120

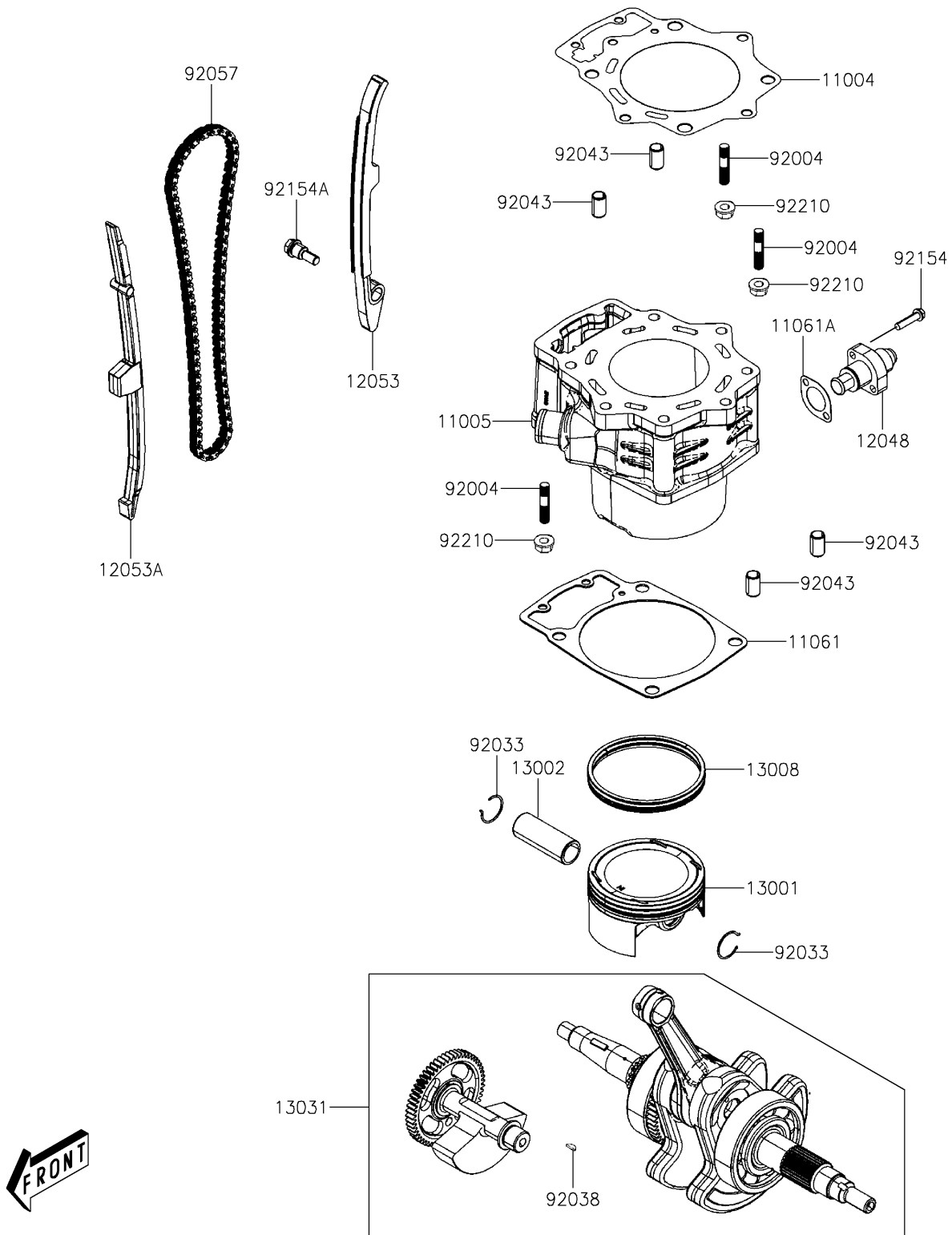

# 2026 MULE PRO-MX™ EPS

## PARTS LIST

Cylinder/Piston(s)

**ITEM NAME**

**PART NUMBER**

**QUANTITY**

---