

# 2026 Mule PRO-MX

## PARTS DIAGRAM

Meter(s)

F2530

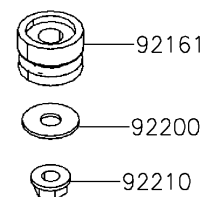
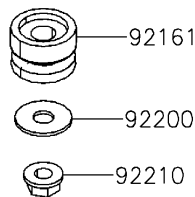
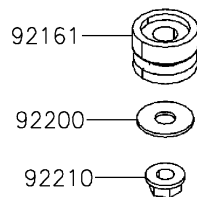
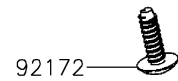
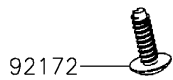
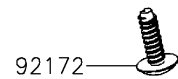
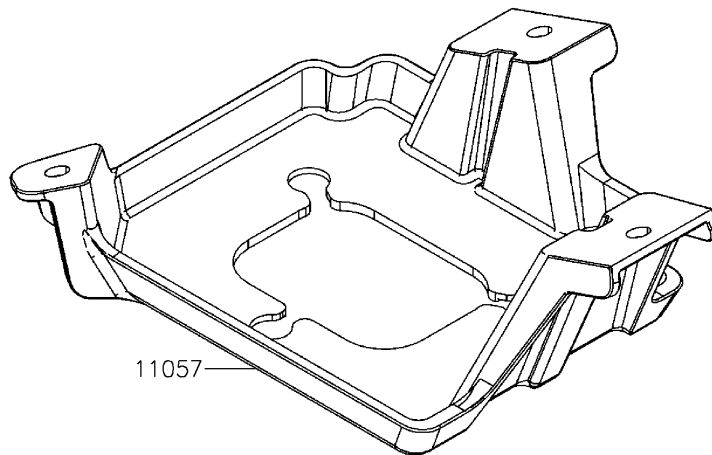
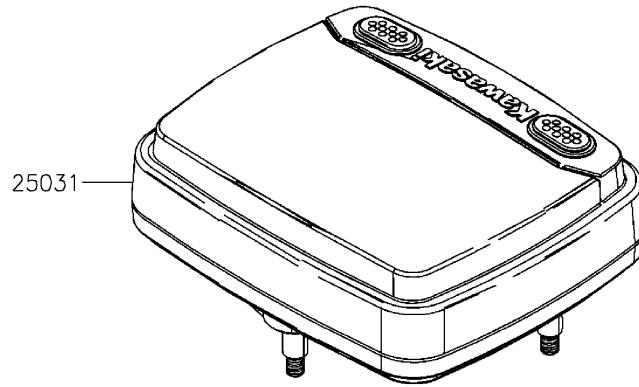

# 2026 Mule PRO-MX

## PARTS LIST

Meter(s)

**ITEM NAME**

**PART NUMBER**

**QUANTITY**

---