

# 2024 Mule PRO-MX

## PARTS DIAGRAM

Meter(s)

F2530

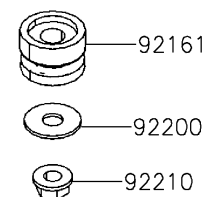
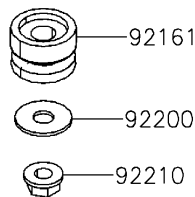
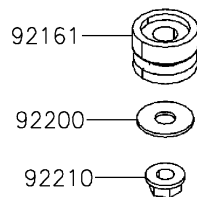
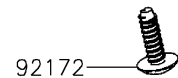
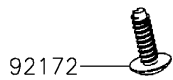
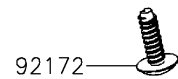
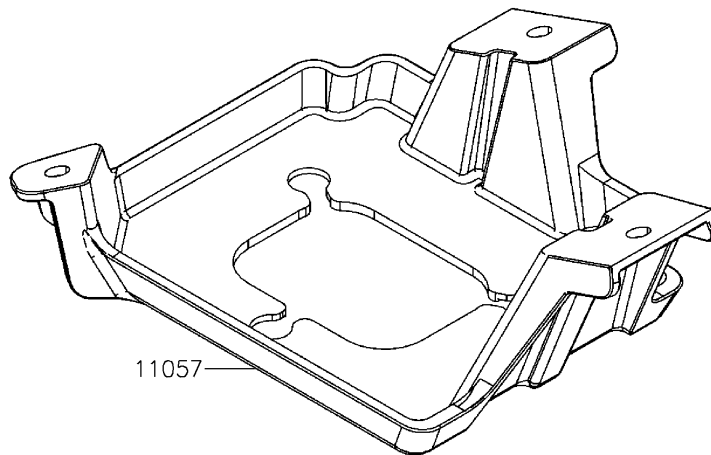
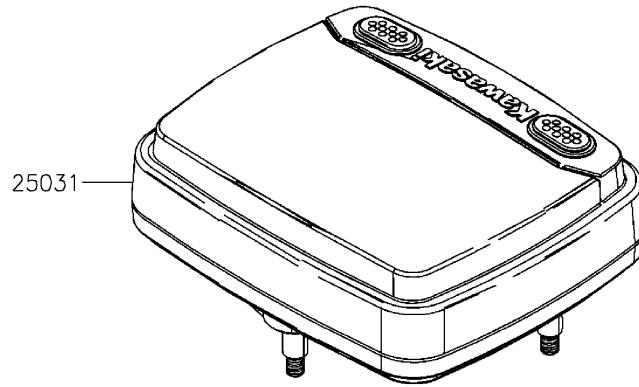

# 2024 Mule PRO-MX

## PARTS LIST

Meter(s)



ITEM NAME	PART NUMBER	QUANTITY
-----------	-------------	----------

---