

# 2022 MULE PRO-MX™ SE

## PARTS DIAGRAM

### Generator

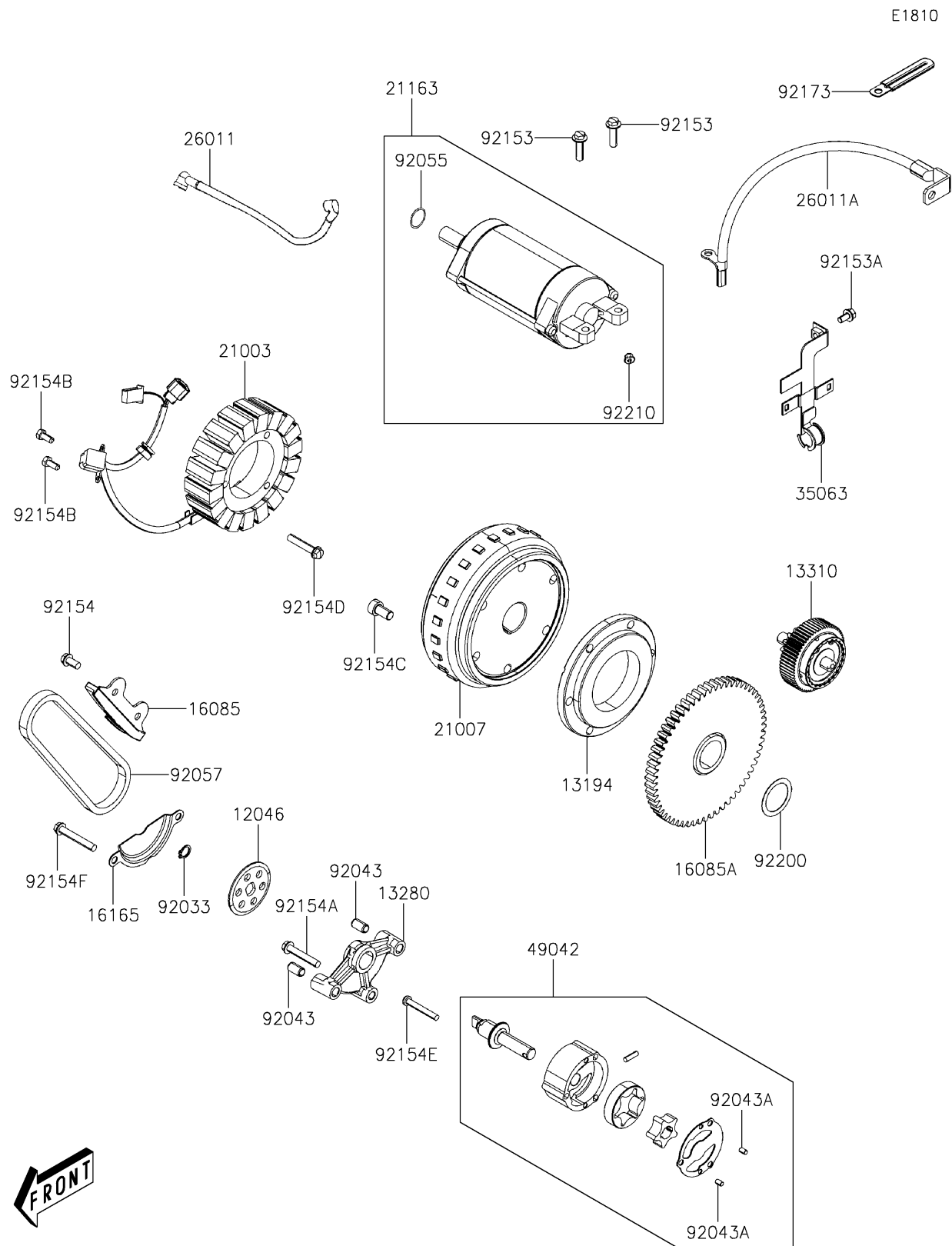

# 2022 MULE PRO-MX™ SE

## PARTS LIST

### Generator

**ITEM NAME**

**PART NUMBER**

**QUANTITY**

---