

2023 Mule PRO-MX EPS LE

PARTS DIAGRAM

Meter(s)

F2530

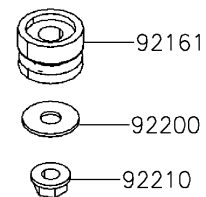
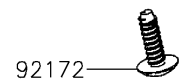
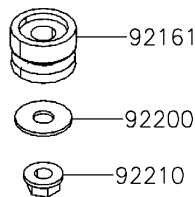
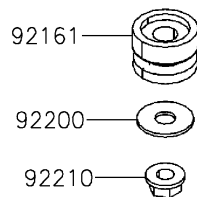
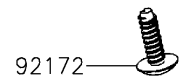
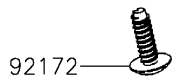
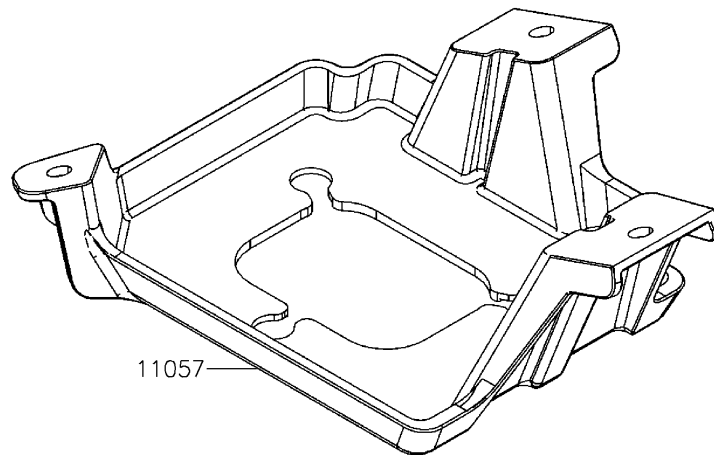
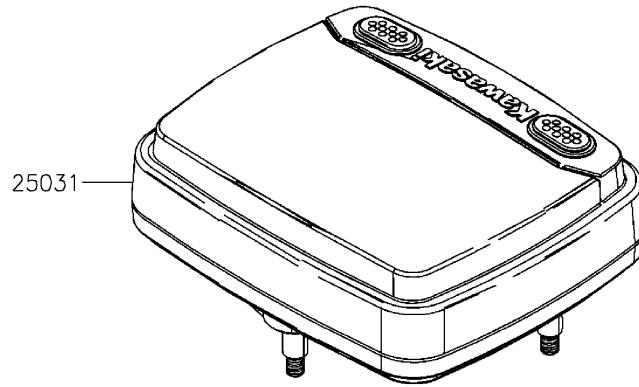

2023 Mule PRO-MX EPS LE

PARTS LIST

Meter(s)

ITEM NAME

PART NUMBER

QUANTITY
