

2021 MULE PRO-MX™

PARTS DIAGRAM

Meter(s)

F2530

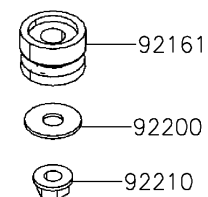
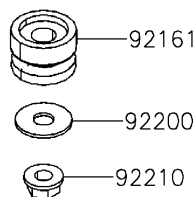
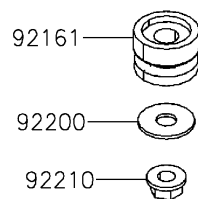
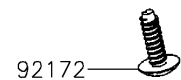
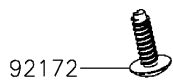
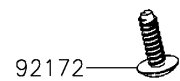
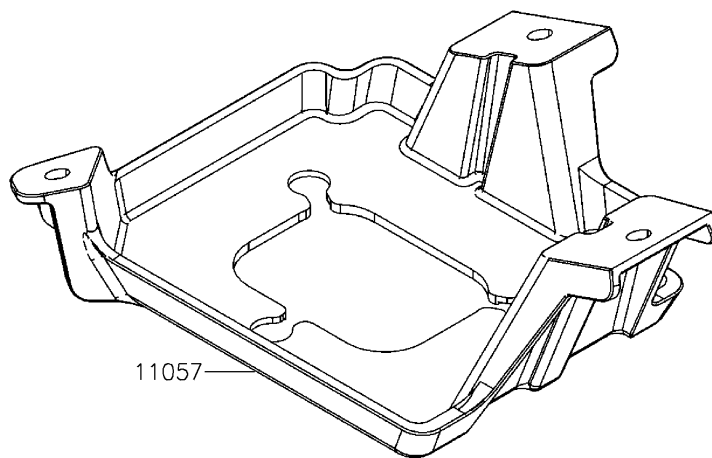
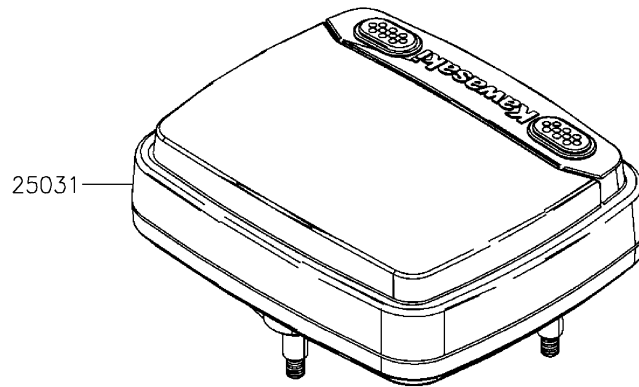

2021 MULE PRO-MX™

PARTS LIST

Meter(s)

ITEM NAME

PART NUMBER

QUANTITY
