

2021 MULE PRO-MX™ EPS

PARTS DIAGRAM

Meter(s)

F2530

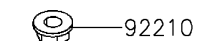
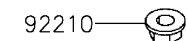
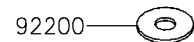
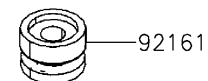
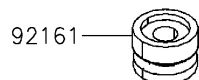
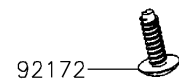
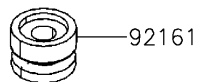
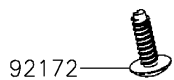
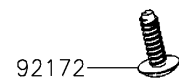
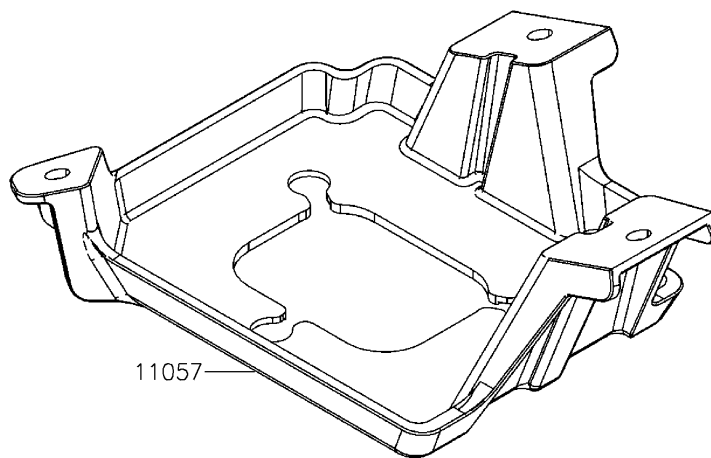
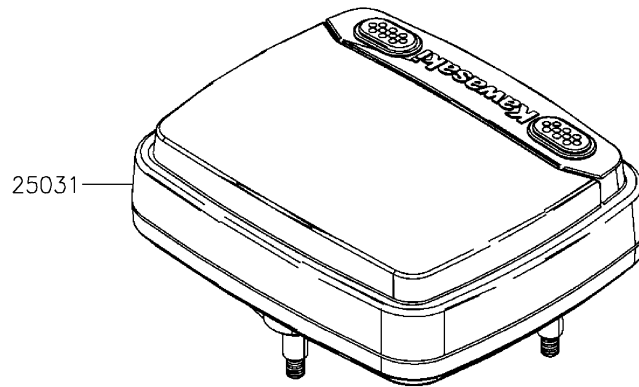

2021 MULE PRO-MX™ EPS

PARTS LIST

Meter(s)

ITEM NAME

PART NUMBER

QUANTITY
