

# 2026 JET SKI® ULTRA® 160LX

## PARTS DIAGRAM

### Cylinder Head

E1111

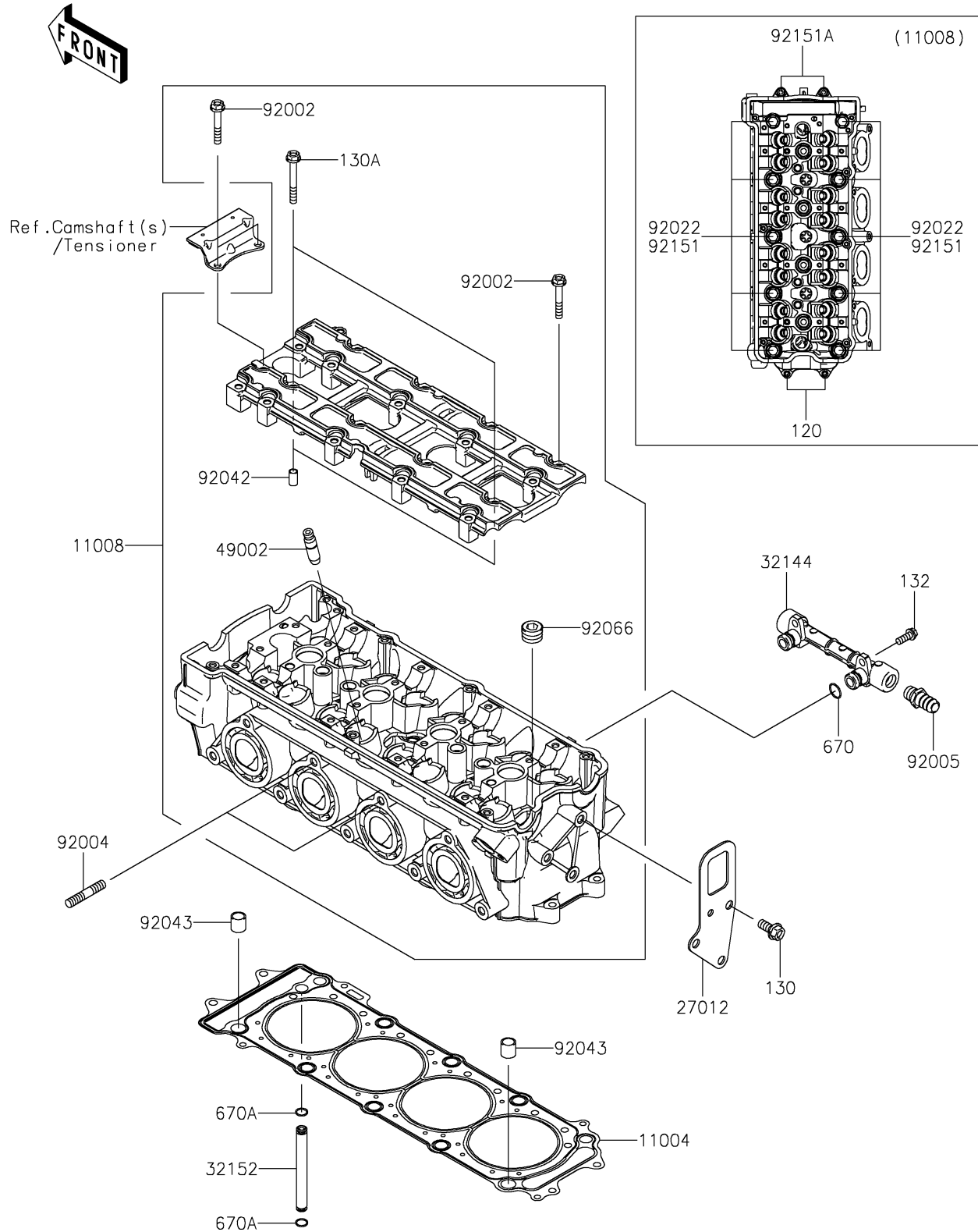

# 2026 JET SKI® ULTRA® 160LX

## PARTS LIST

### Cylinder Head



**ITEM NAME**

**PART NUMBER**

**QUANTITY**

---