

# 2023 VULCAN® 1700 VAQUERO® ABS

## PARTS DIAGRAM

### Frame

F2120

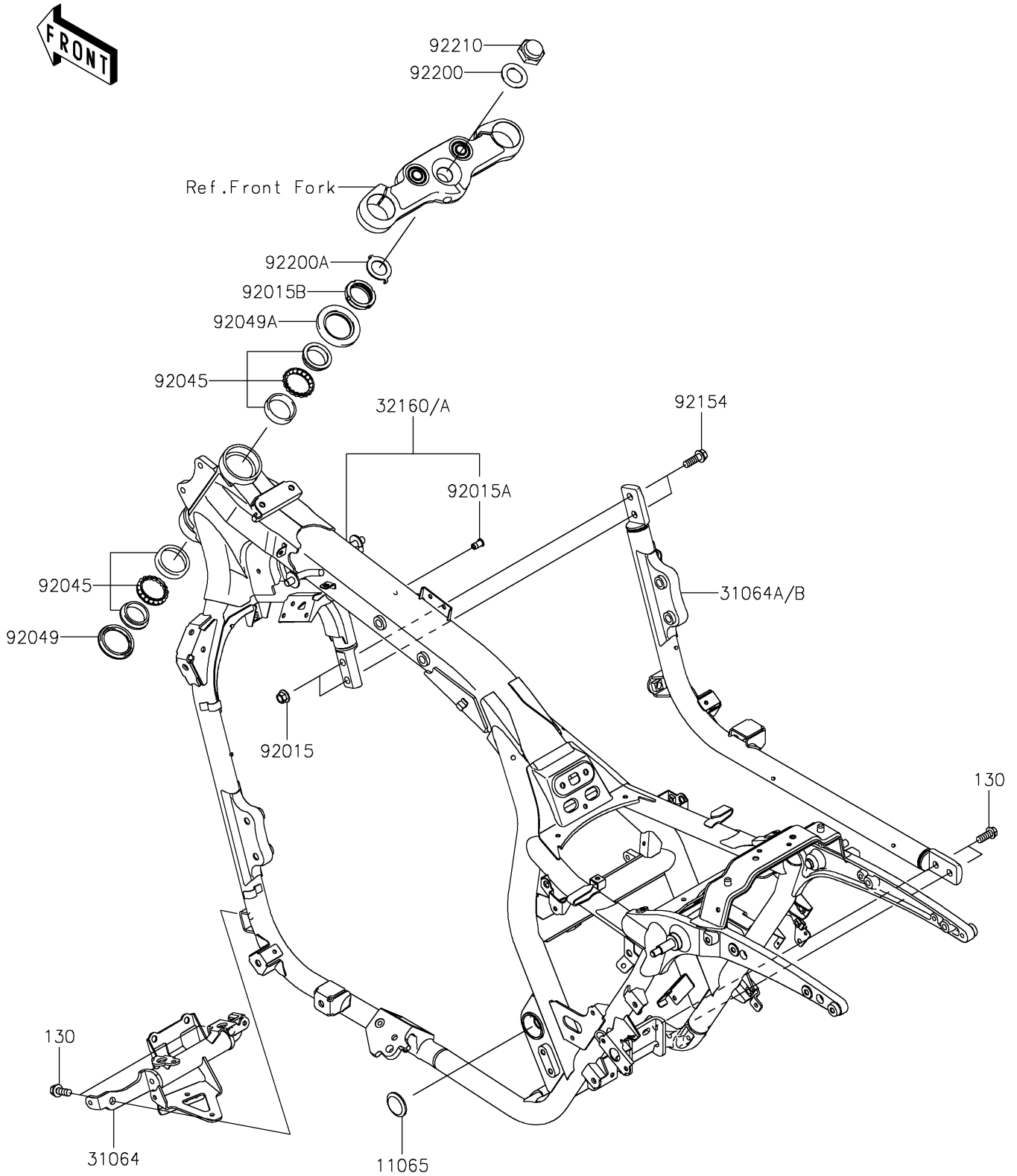

# 2023 VULCAN® 1700 VAQUERO® ABS



## PARTS LIST

### Frame

ITEM NAME	PART NUMBER	QUANTITY
-----------	-------------	----------

---