

# 2026 NINJA® ZX™-6R

## PARTS DIAGRAM

### Handlebar

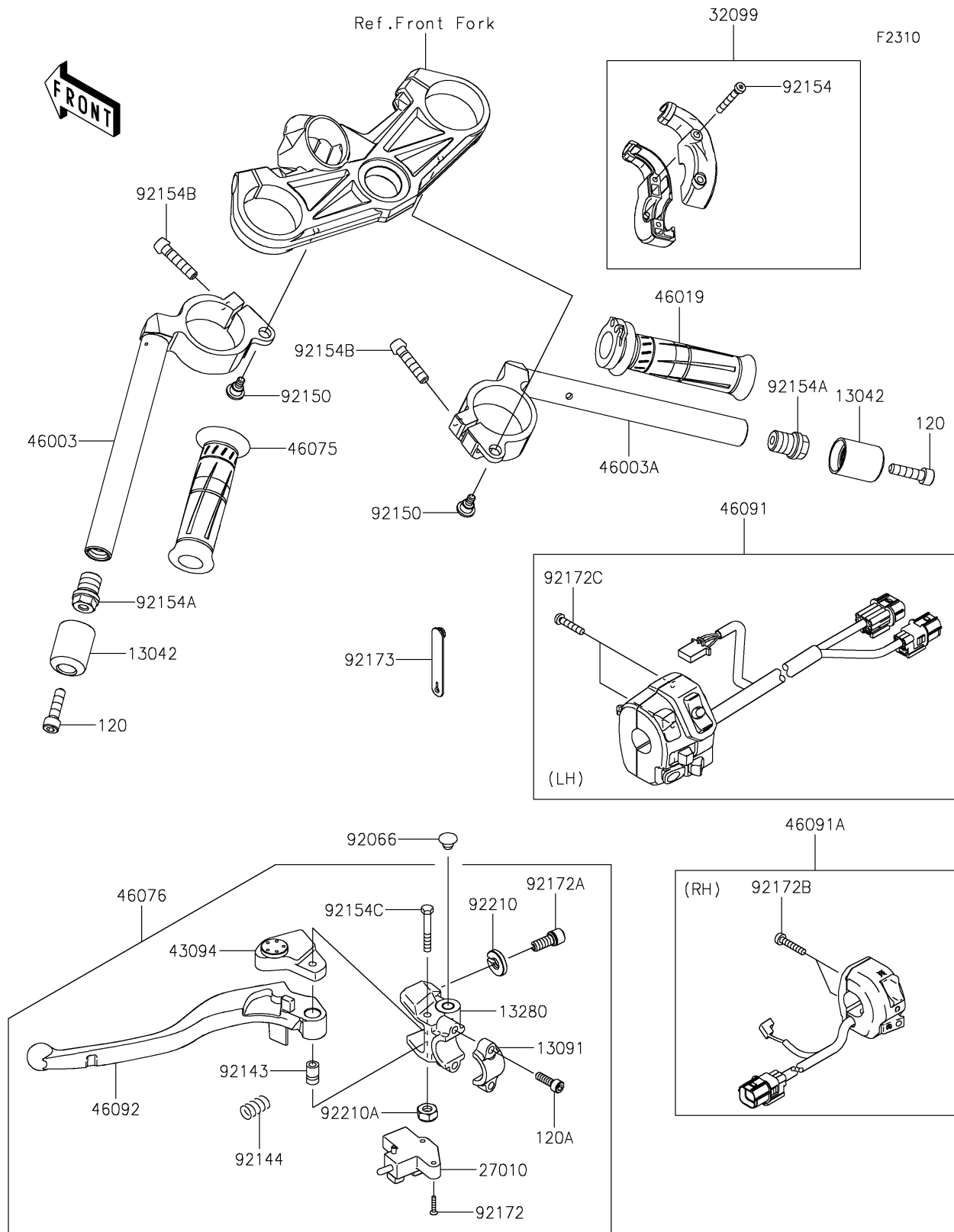

# 2026 NINJA® ZX™-6R

## PARTS LIST

### Handlebar

**ITEM NAME**

**PART NUMBER**

**QUANTITY**

---