

# 2026 NINJA® ZX™-6R

## PARTS DIAGRAM

### Rear Brake

F2294

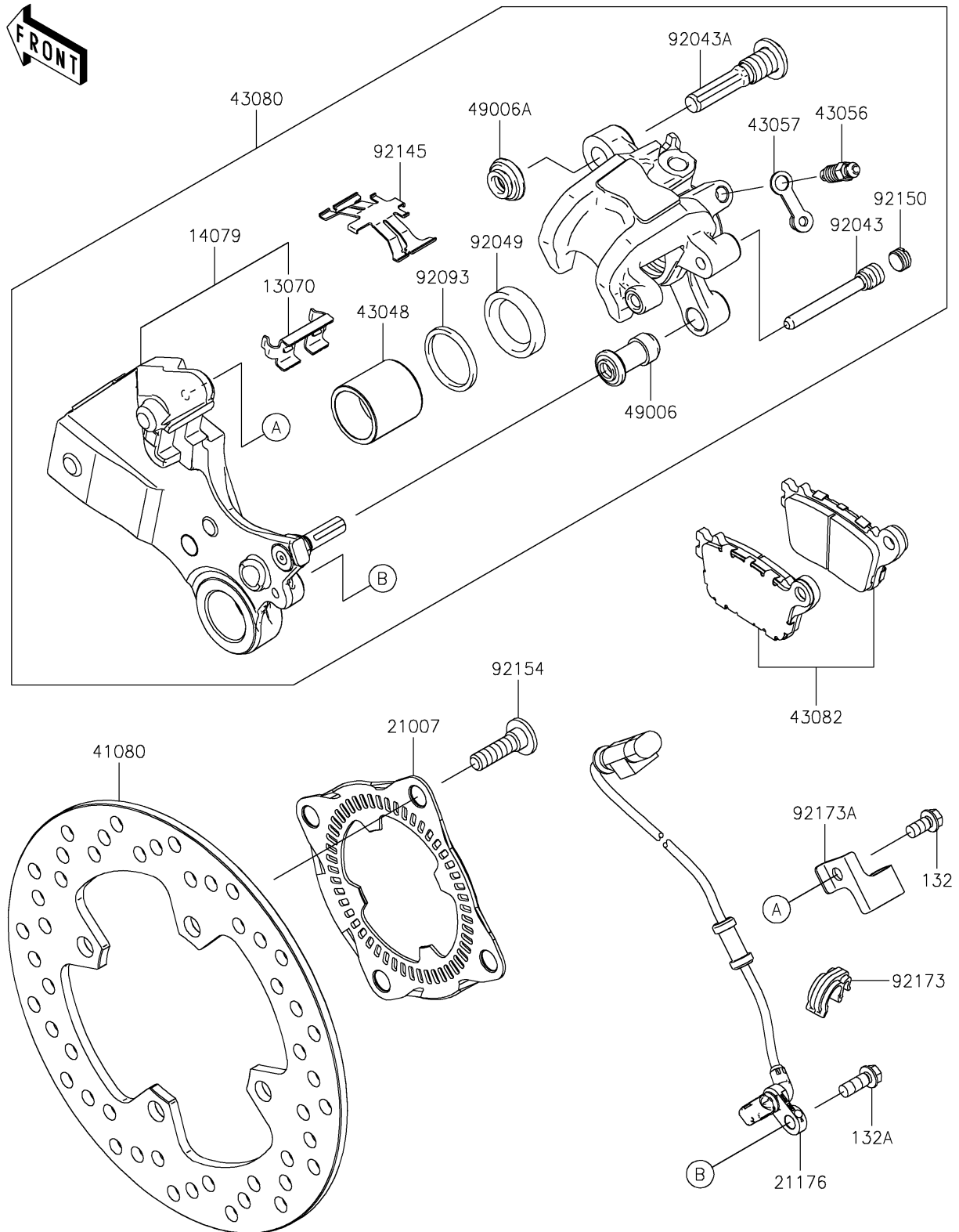

# 2026 NINJA<sup>®</sup> ZX<sup>™</sup>-6R

## PARTS LIST

### Rear Brake



**ITEM NAME**

**PART NUMBER**

**QUANTITY**

---