

# 2026 NINJA<sup>®</sup> ZX<sup>™</sup>-6R

## PARTS DIAGRAM

### Front Wheel

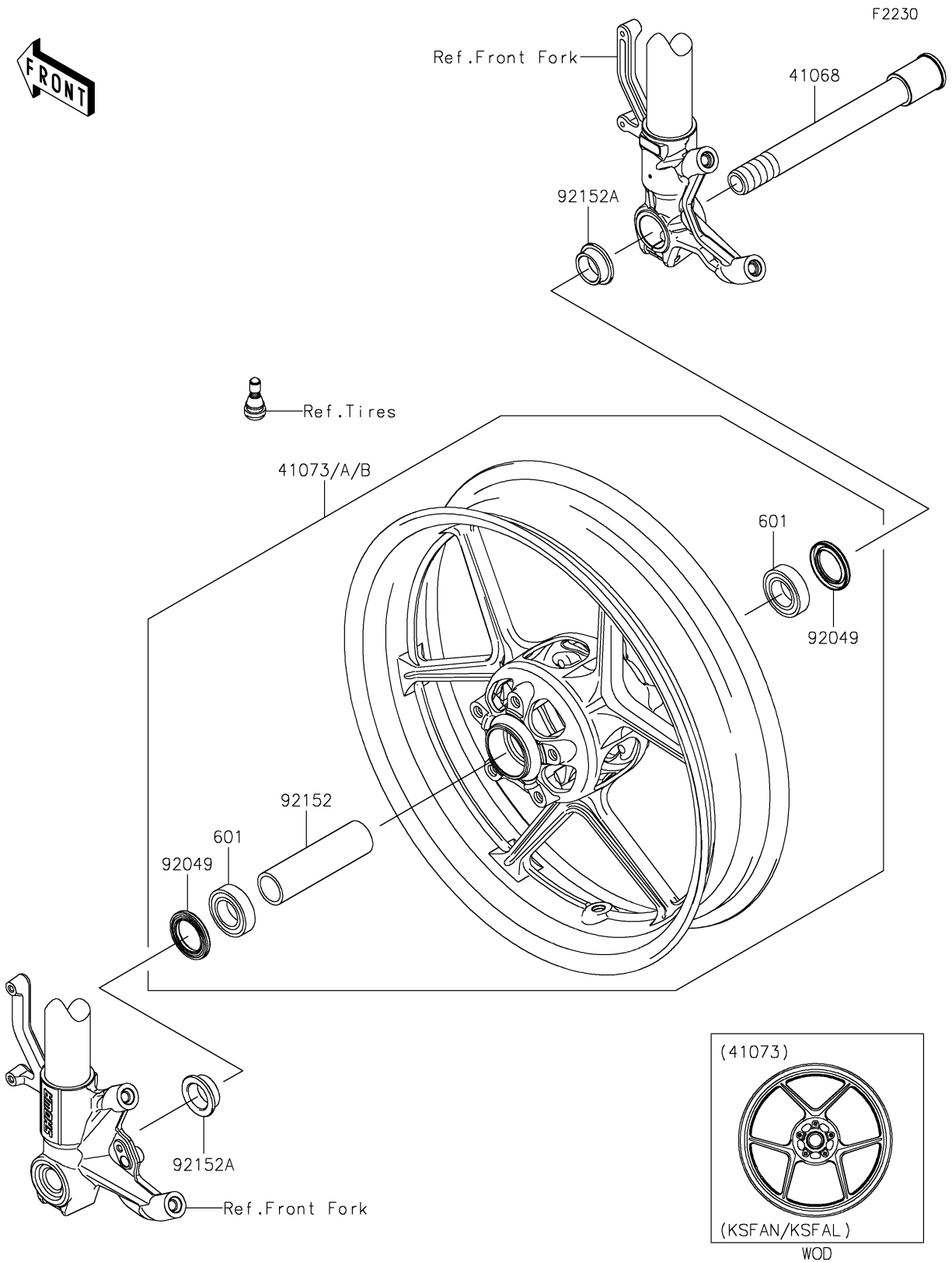

# 2026 NINJA® ZX™-6R

## PARTS LIST

### Front Wheel

**ITEM NAME**

**PART NUMBER**

**QUANTITY**

---