

# 2016 Ninja ZX-6R ABS

## PARTS DIAGRAM

### Owner's Tools

F2810

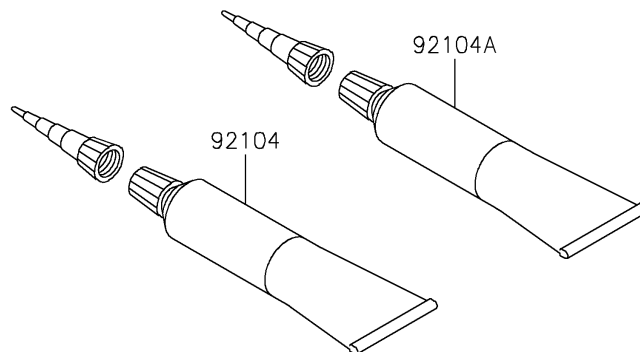
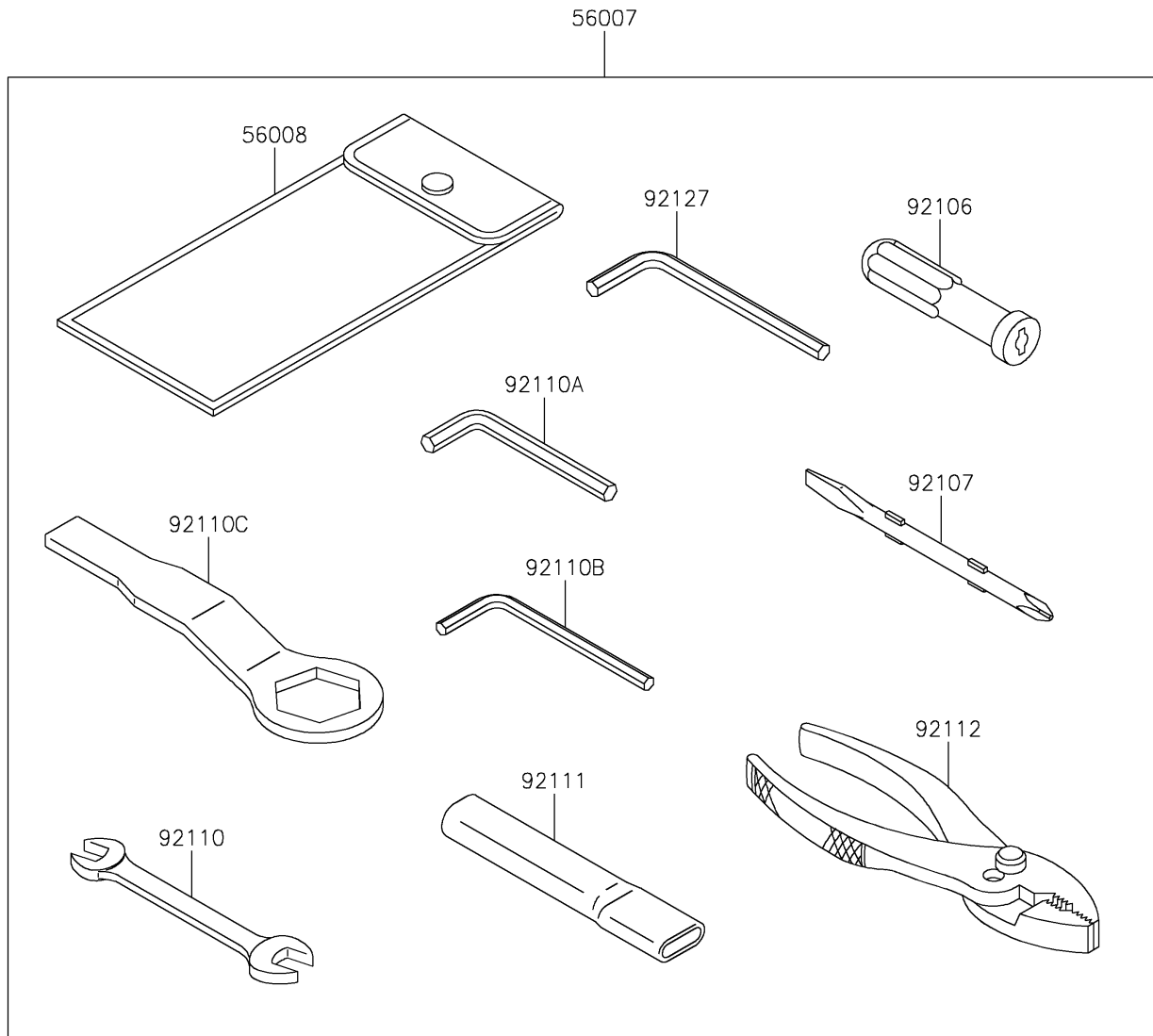

# 2016 Ninja ZX-6R ABS

## PARTS LIST

### Owner's Tools

**ITEM NAME**

**PART NUMBER**

**QUANTITY**

---