

2016 Ninja ZX-6R

PARTS DIAGRAM

Meter(s)

F2530

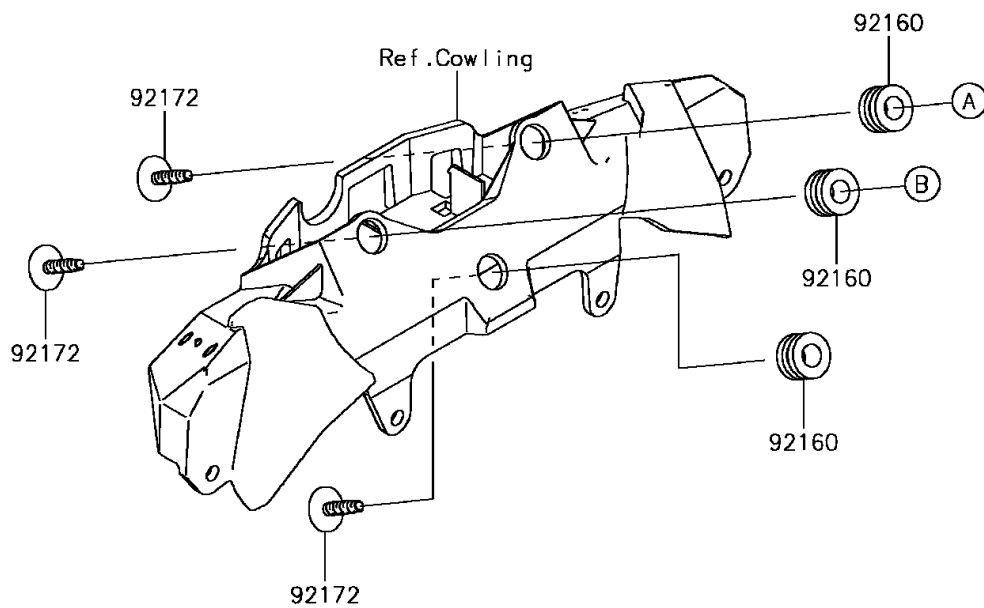
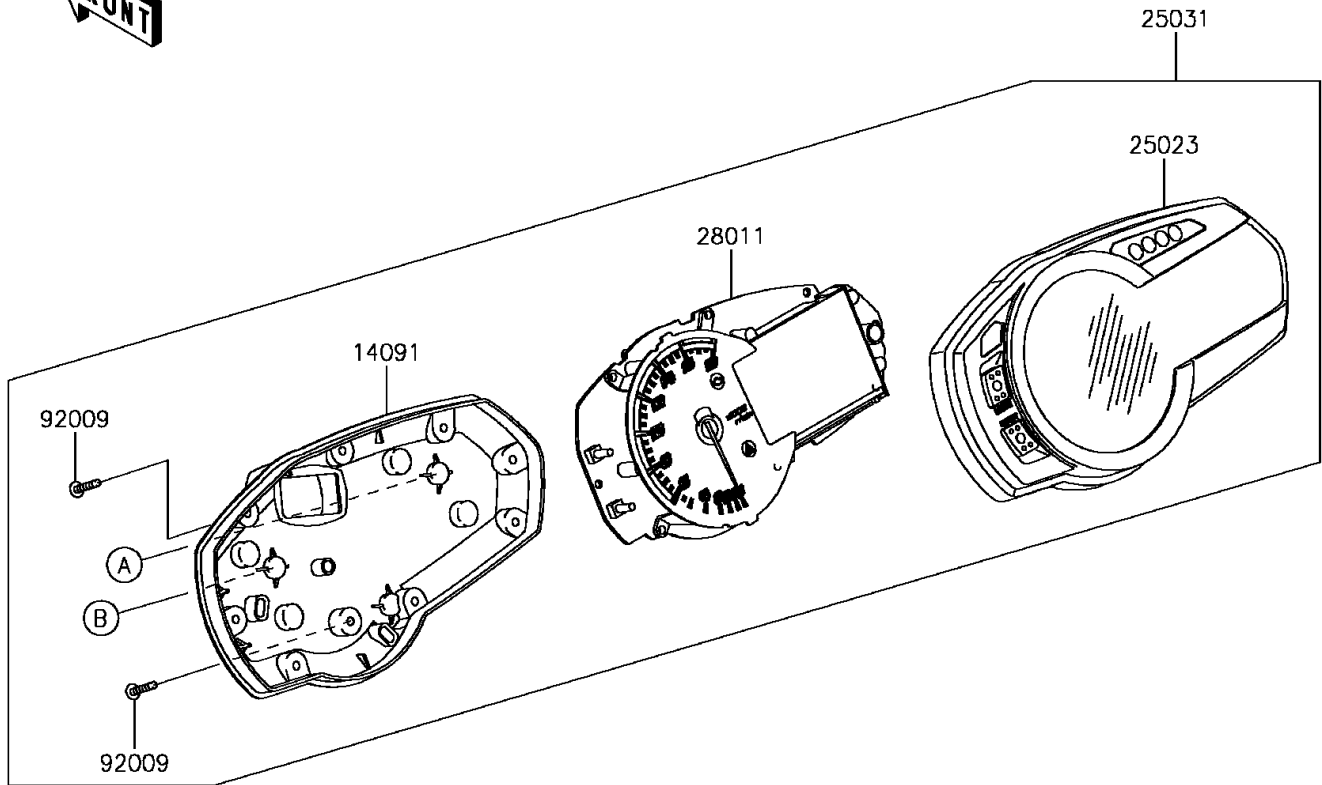

2016 Ninja ZX-6R

PARTS LIST

Meter(s)

ITEM NAME	PART NUMBER	QUANTITY
COVER,METER,LWR (Ref # 14091)	14091-1739	1
COVER-METER CASE,UPP (Ref # 25023)	25023-0047	1
METER-ASSY,COMBINATION (Ref # 25031)	25031-0434	1
METER,TACHO&LCD (Ref # 28011)	28011-0581	1
SCREW,TAPPING,3X16 (Ref # 92009)	92009-1391	9
DAMPER,10X20X12 (Ref # 92160)	92160-1167	3
SCREW,TAPPING,WP,5X14 (Ref # 92172)	92172-0441	3