

# 2014 NINJA<sup>®</sup> ZX<sup>™</sup>-6R

## PARTS DIAGRAM

Stand(s)

F2190

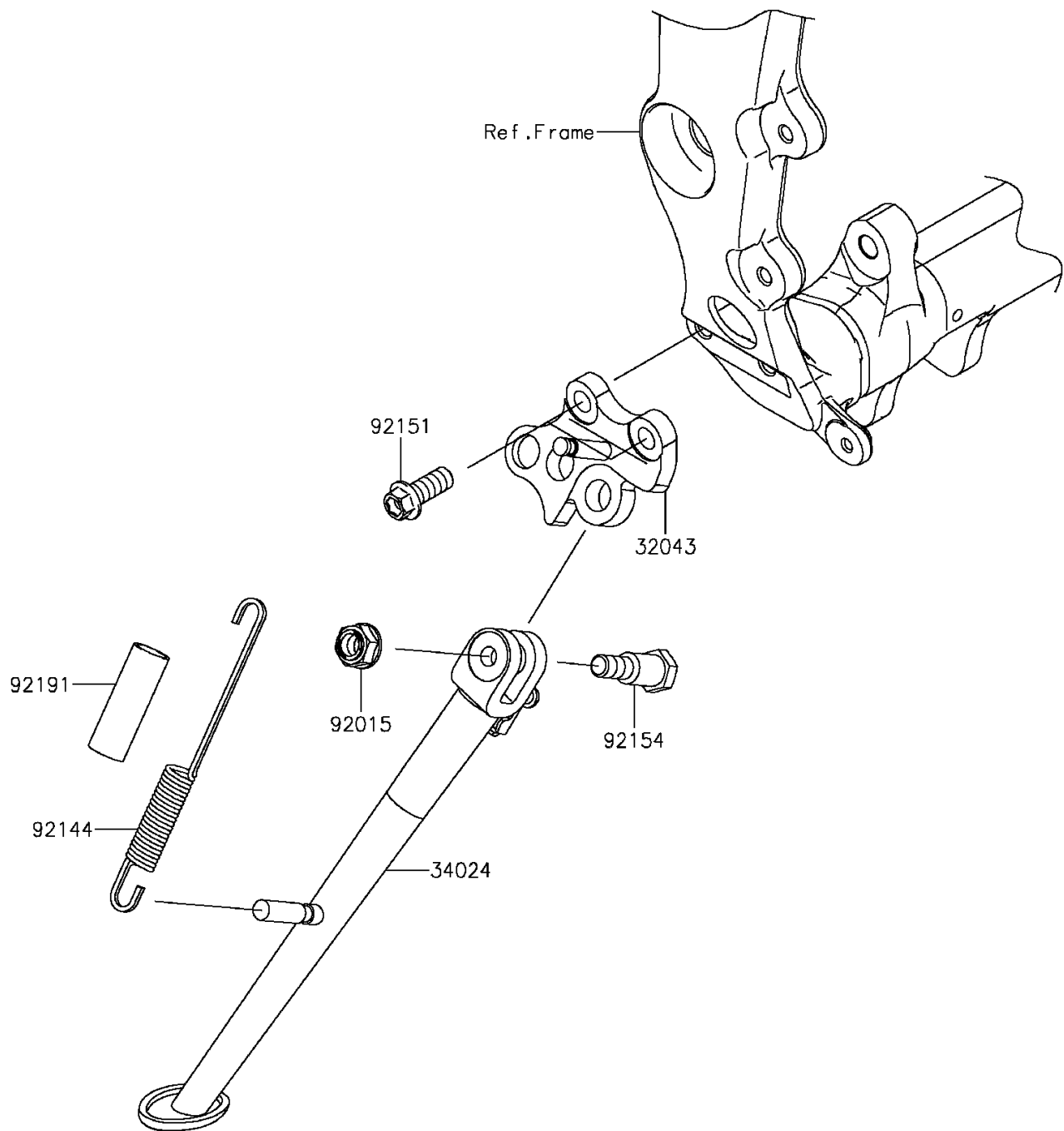

# 2014 NINJA® ZX™-6R

## PARTS LIST

Stand(s)

**ITEM NAME**

**PART NUMBER**

**QUANTITY**

---