

2024 Ninja® ZX-6R ABS

PARTS DIAGRAM

Owner's Tools

F2810

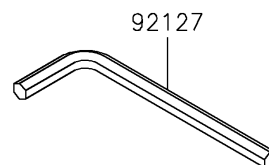
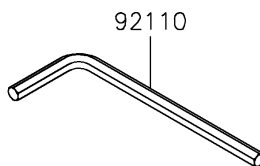
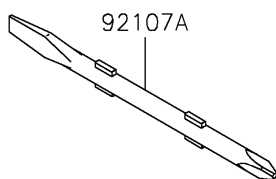
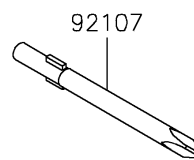
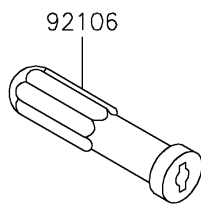
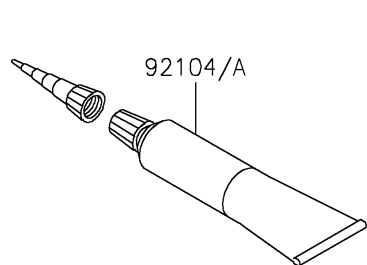
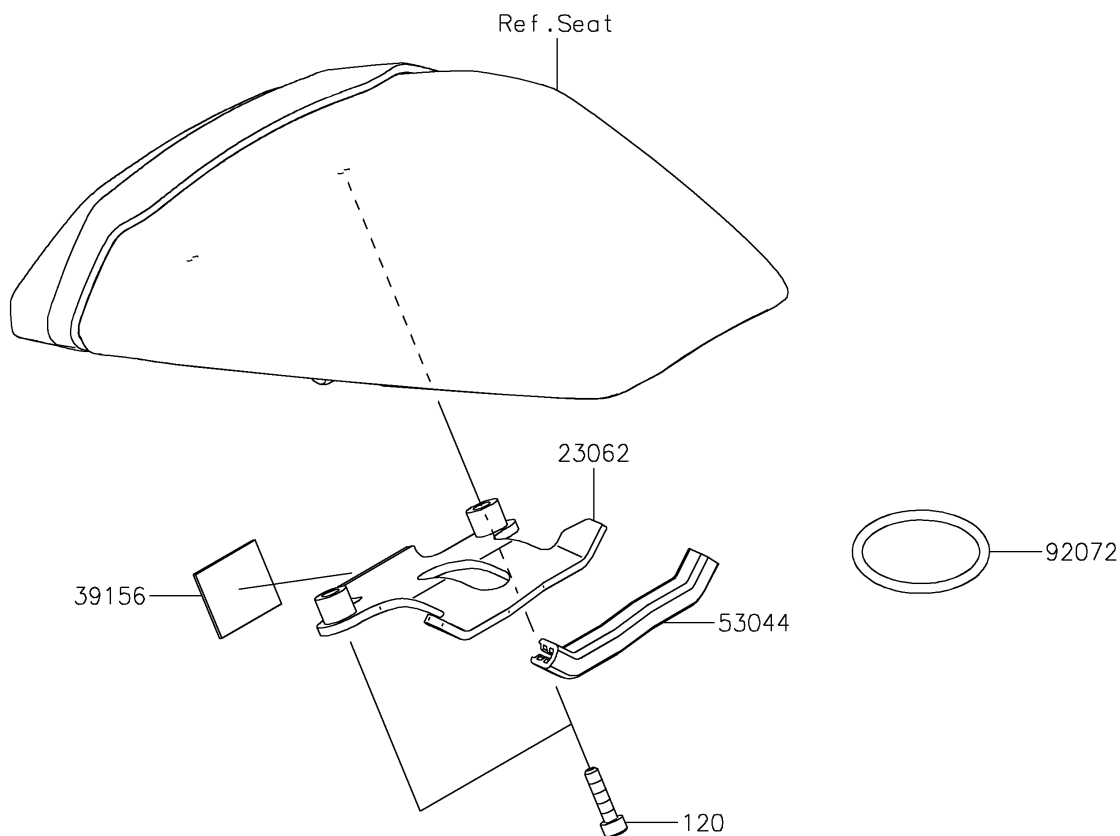

2024 Ninja® ZX-6R ABS

PARTS LIST

Owner's Tools

ITEM NAME

PART NUMBER

QUANTITY
