

# 2023 NINJA® ZX™-6R

## PARTS DIAGRAM

Decals(Blue)(HNFNN/HNFNL/HPFNN/HPFNL)

F2861

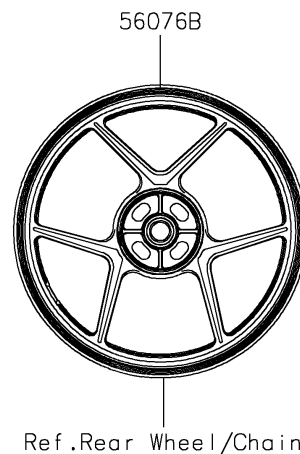
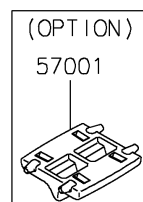
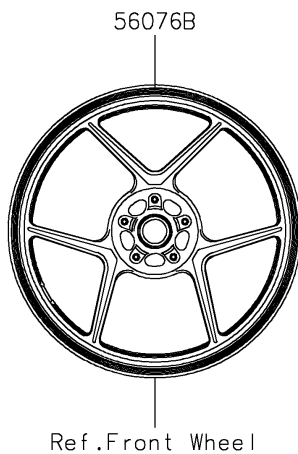
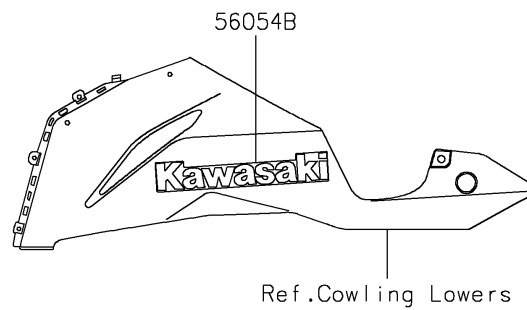
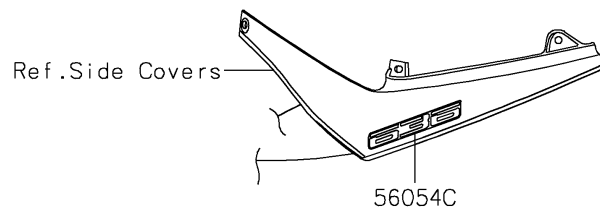
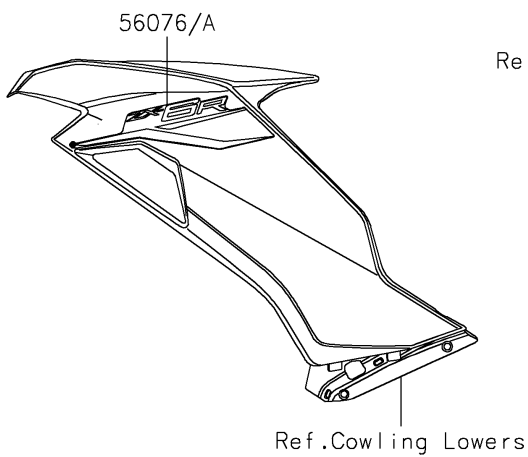
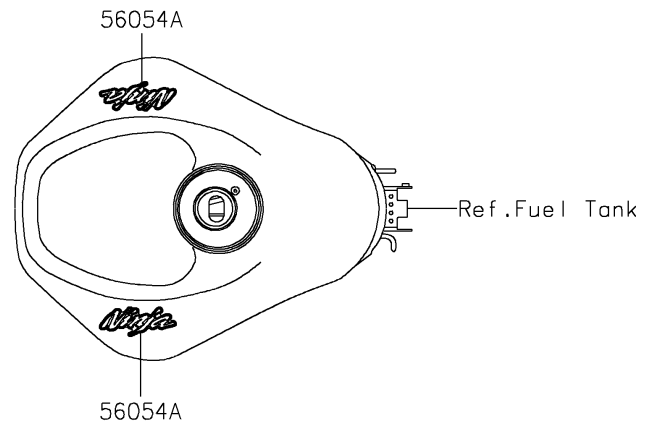
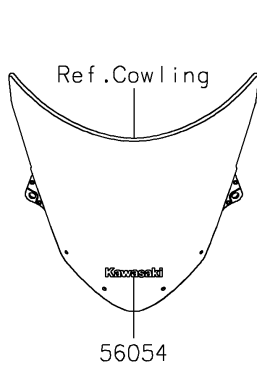

# 2023 NINJA<sup>®</sup> ZX<sup>™</sup>-6R

## PARTS LIST

Decals(Blue)(HNFNN/HNFNL/HPFNN/HPFNL)

**ITEM NAME**

**PART NUMBER**

**QUANTITY**

---