

2020 NINJA® ZX™ -6R ABS

PARTS DIAGRAM

Meter(s)

F2530

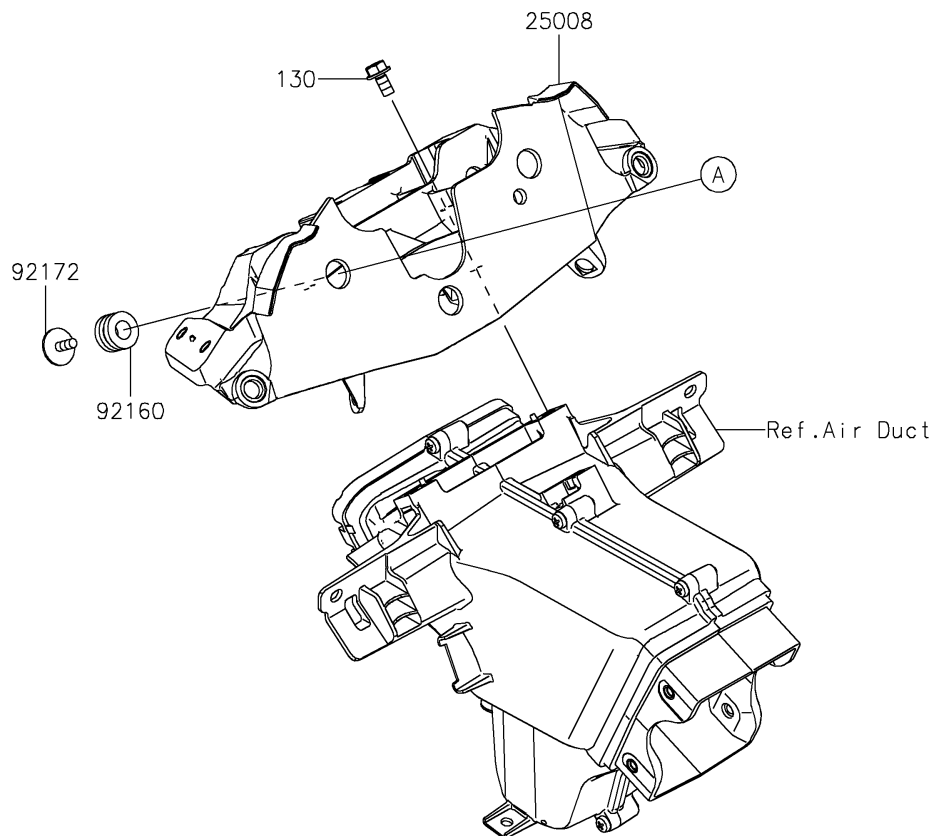
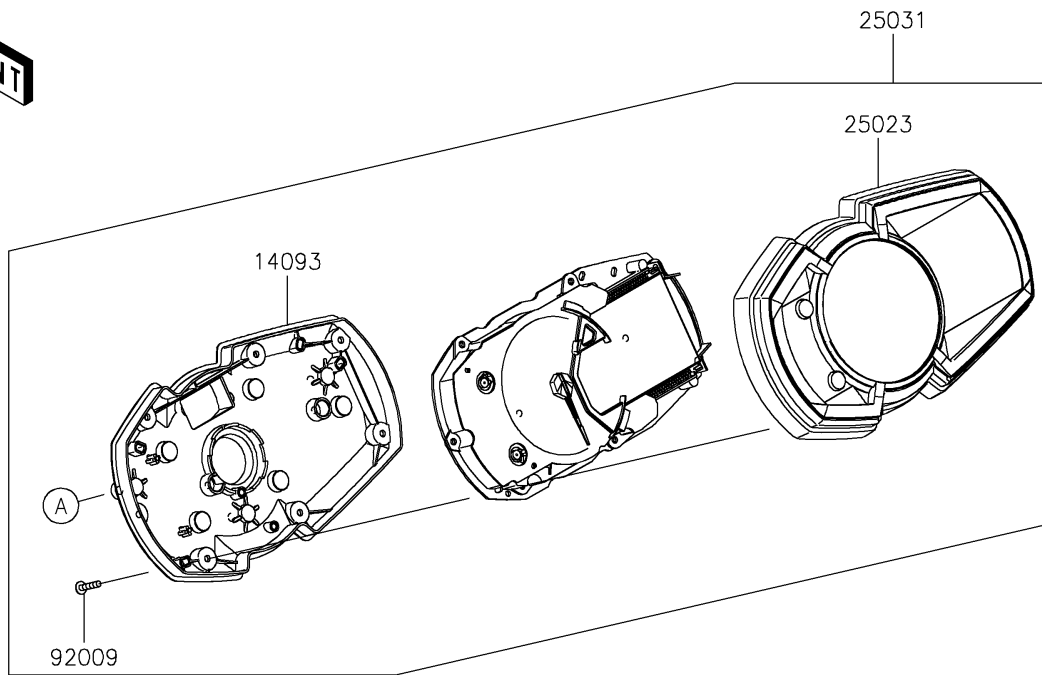

2020 NINJA® ZX™-6R ABS

PARTS LIST

Meter(s)

ITEM NAME	PART NUMBER	QUANTITY
-----------	-------------	----------
