

2020 NINJA® ZX™ -6R ABS

PARTS DIAGRAM

Footrests

F2160

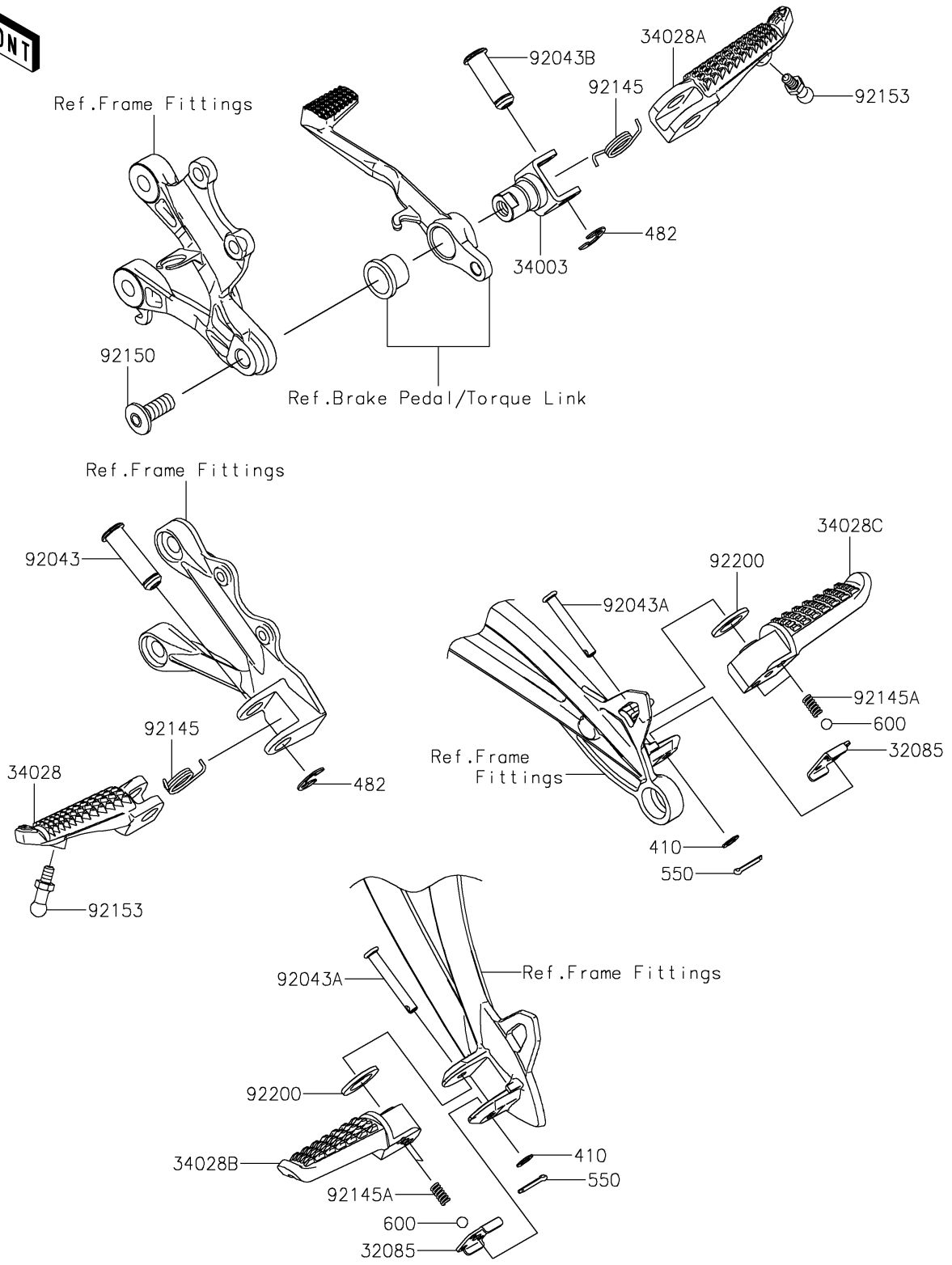

2020 NINJA® ZX™-6R ABS

PARTS LIST

Footrests

ITEM NAME	PART NUMBER	QUANTITY
-----------	-------------	----------
