

# 2020 NINJA® ZX™ -6R ABS

## PARTS DIAGRAM

### Oil Pan

E1434

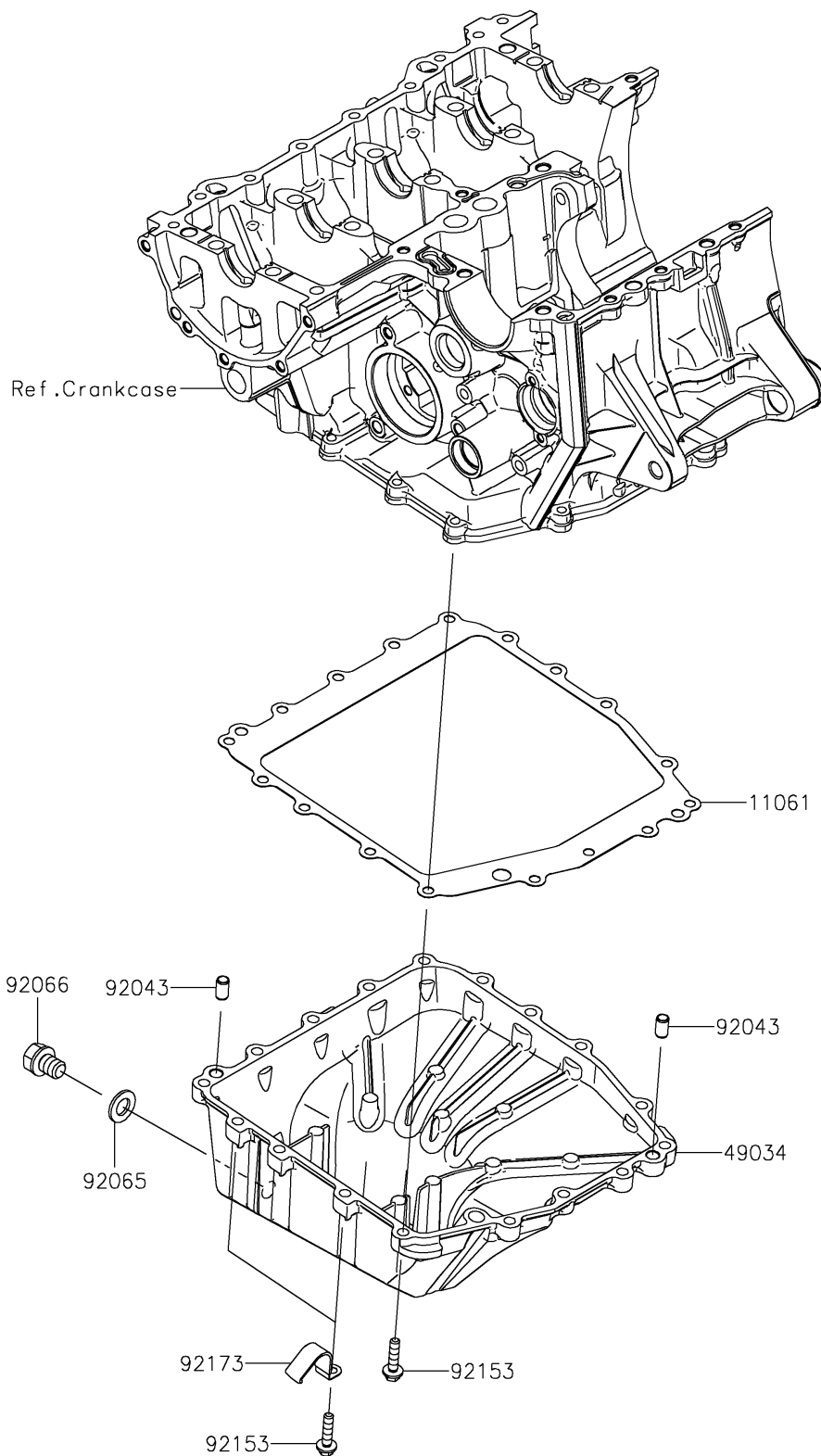

# 2020 NINJA® ZX™-6R ABS

## PARTS LIST

Oil Pan

ITEM NAME	PART NUMBER	QUANTITY
-----------	-------------	----------

---