

2018 NINJA® ZX™-6R ABS

PARTS DIAGRAM

Handlebar

F2310

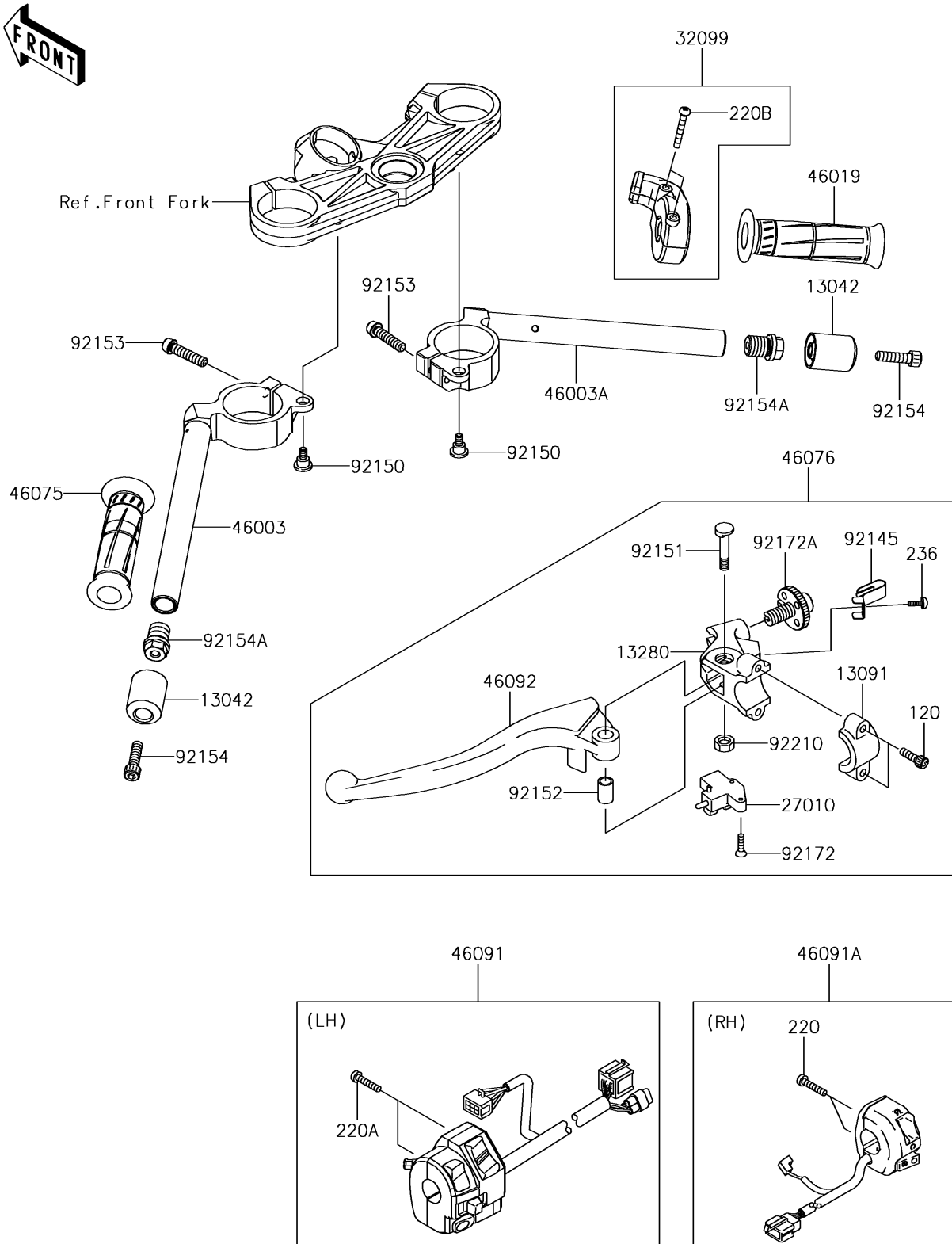

2018 NINJA® ZX™ -6R ABS

PARTS LIST

Handlebar

ITEM NAME	PART NUMBER	QUANTITY
-----------	-------------	----------
