

# 2018 NINJA<sup>®</sup> ZX<sup>™</sup>-6R

## PARTS DIAGRAM

### Handlebar

F2310

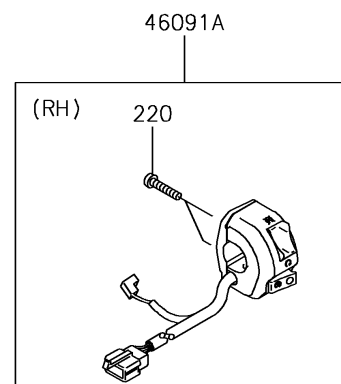
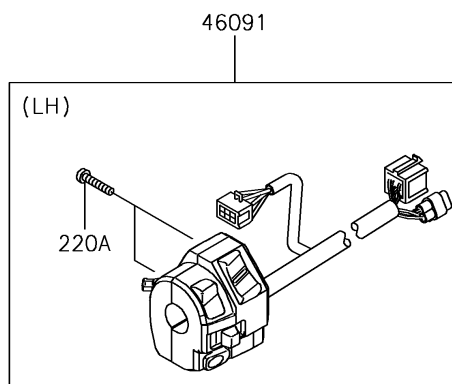
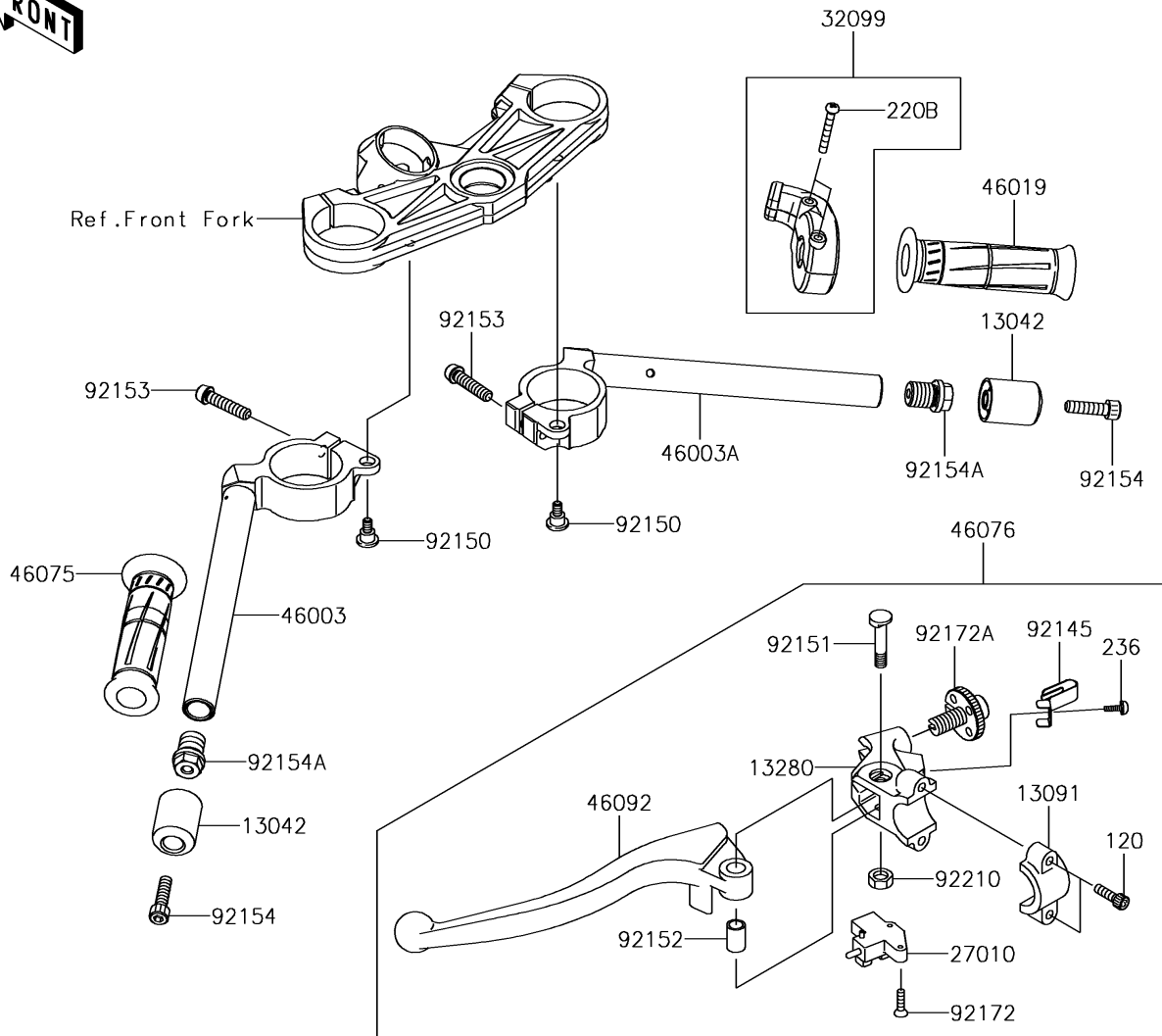

# 2018 NINJA<sup>®</sup> ZX<sup>™</sup>-6R

## PARTS LIST

### Handlebar

**ITEM NAME**

**PART NUMBER**

**QUANTITY**

---