

# 2026 Z125 PRO

## PARTS DIAGRAM

### Camshaft(s)/Tensioner

E1230

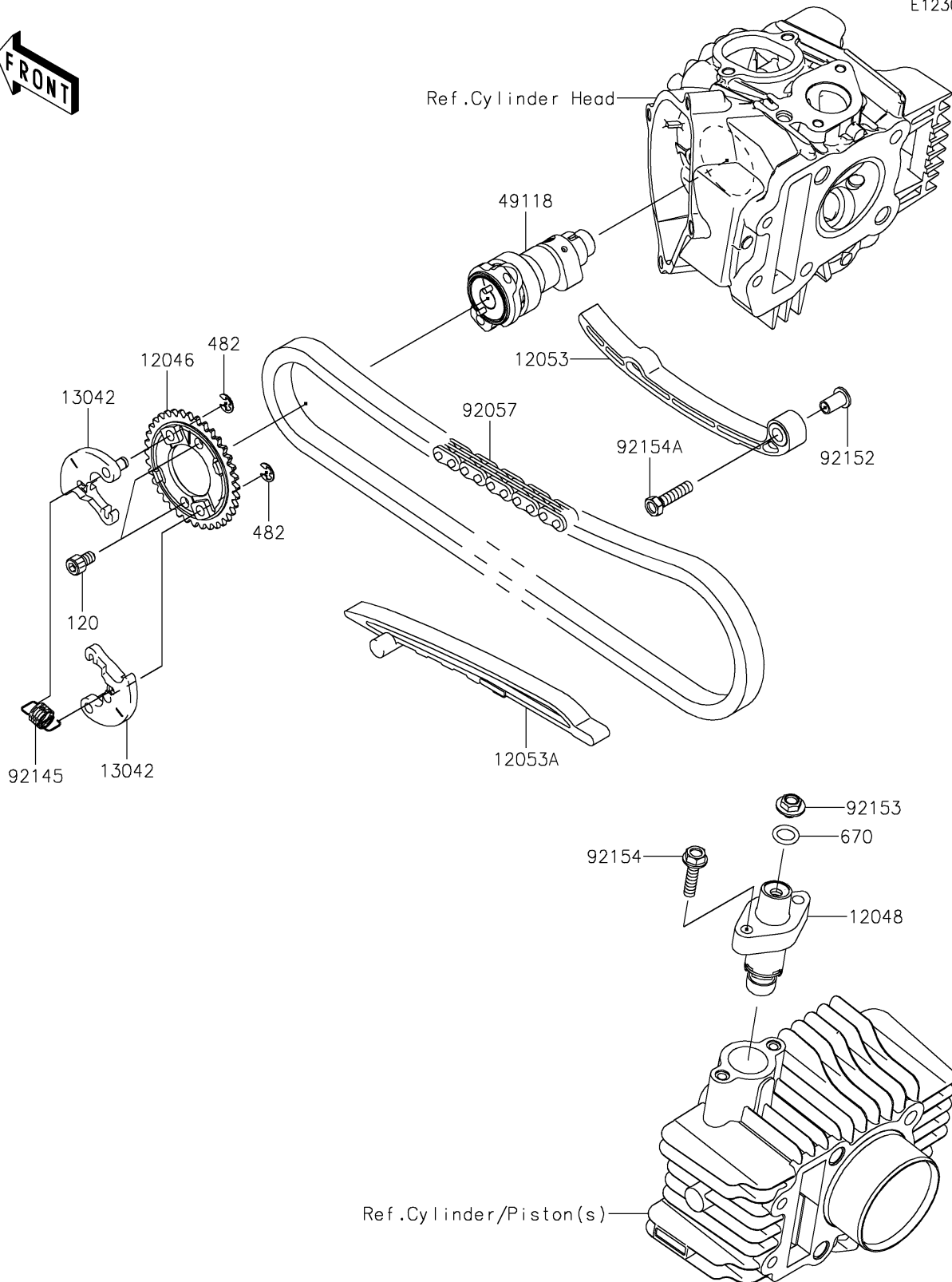

# 2026 Z125 PRO

## PARTS LIST

### Camshaft(s)/Tensioner

ITEM NAME	PART NUMBER	QUANTITY
SPROCKET,36T (Ref # 12046)	12046-0596	1
TENSIONER-ASSY (Ref # 12048)	12048-0097	1
GUIDE-CHAIN (Ref # 12053)	12053-0185	1
GUIDE-CHAIN (Ref # 12053A)	12053-1461	1
WEIGHT,DECOMP (Ref # 13042)	13042-1141	2
CAMSHAFT-COMP (Ref # 49118)	49118-0863	1
CHAIN,CAM,94L (Ref # 92057)	92057-0610	1
SPRING (Ref # 92145)	92145-0132	1
COLLAR,CHAIN GUIDE (Ref # 92152)	92152-1369	1
BOLT,FLANGED,6X6 (Ref # 92153)	92153-1763	1
BOLT,FLANGED,6X25 (Ref # 92154)	92154-1196	2
BOLT,6X25 (Ref # 92154A)	92154-2191	1
BOLT-SOCKET,6X10 (Ref # 120)	120CA0610	2
CIRCLIP-TYPE-E,5MM (Ref # 482)	482J5000	2
O RING,10MM (Ref # 670)	670D2010	1